

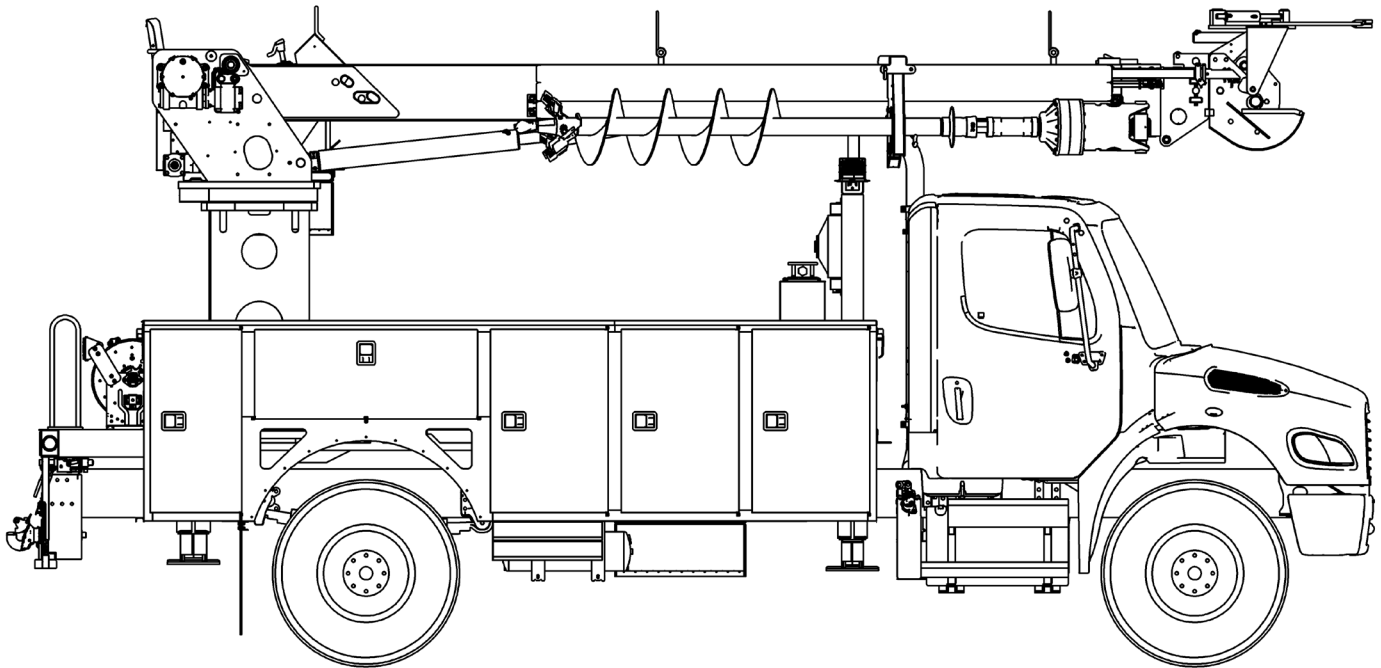

# TECH TIPS

TROUBLESHOOTING COMMUNICATION ISSUES ON A RADIO CONTROLLED  
DIGGER DERRICK

NO. 114



**SERVICE CALL:**  
TROUBLESHOOTING  
COMMUNICATIONS ISSUES ON  
RADIO CONTROLLED DIGGER  
DERRICKS



**MODEL(S):**  
ALL TEREX UTILITIES RADIO  
CONTROLLED DIGGER DERRICKS



**TOOLS NEEDED:**  
MULTIMETER  
3 AND 4 MM ALLEN WRENCH  
FLAT BLADE SCREWDRIVER

TEREX UTILITIES TECHNICAL SUPPORT TEAM

PHONE: 1-844-TEREX4U (1-844-837-3948) | EMAIL: [UTILITIES.SERVICE@TEREX.COM](mailto:UTILITIES.SERVICE@TEREX.COM)



## **DANGER**

Failure to obey the instructions and safety rules in the appropriate Operator's Manual and Service Manual for your machine will result in death or serious injury.

Many of the hazards identified in the Operator's Manual are also safety hazards when maintenance and repair procedures are performed.

## **DO NOT PERFORM MAINTENANCE UNLESS:**

- ✓ You are trained and qualified to perform maintenance on this machine.
- ✓ You read, understand and obey:
  - manufacturer's instructions and safety rules
  - employer's safety rules and worksite regulations
  - applicable governmental regulations
- ✓ You have the appropriate tools, lifting equipment and a suitable workshop.

The information contained in this Tech Tip is a supplement to the Service Manual. Consult the appropriate Service Manual of your machine for safety rules and hazards.



TECH TIP 114 | RELEASED 04.21.2023 | VERSION 1.0  
©TEREX UTILITIES. ALL RIGHTS RESERVED

# CONTENTS

## TECH TIP#114

### TOC

4

| Check battery contacts  
| Insert fully charged battery  
| Check e-stop  
| Toggle tools switch

**INTRODUCTION**  
**STEP 1 - STEP 5**

5

| Troubleshooting communication

**STEP 6 - STEP 8**

6

| H1-00240B and H1-00744

**STEP 9**

8

| H1-01114

**STEP 12**

10

| H1-010787

**STEP 14**

11

| All Radio Types

**STEP 15 - STEP 16**

## INTRODUCTION

Before beginning to troubleshoot a communications issue, always verify that the controls will work when switched to manual controls. If boom functions are working, then proceed to troubleshooting the radio. If not, then troubleshoot the hydraulic system.

Steps 1 – 5 take you through some quick checks to perform before troubleshooting further.

These steps are for all Hetronic radio types H1-00240, H1-00744, H1-01114 and H1-00787

## STEP 1

Check that the battery contacts are clean and move freely.



## STEP 2

Insert a fully charged battery from the charger into the transmitter.

## STEP 3

Verify that the transmitter E-stop switch is not pushed down.

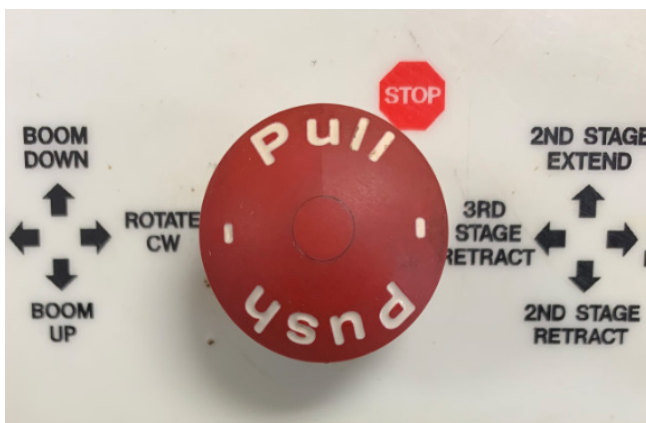

## STEP 4

Toggle the Tools switch to the “OFF” position and allow the tool switch return to the center position.

## STEP 5

After performing Steps 1 – 4, retest the radio operation before proceeding.



## STEP 6

Check that the transmitter (hand held remote) is powering up and going through its startup cycle: Turn transmitter key "ON" a quarter turn and get two series of beeps and the green LED light is flashing slow.

Push the tilt/reset switch for 1 second, release and verify that the horn honks or beeps.

## STEP 7

If there is no communication between the transmitter and the receiver after Step 6, turn OFF the transmitter and exercise the two thumb joysticks back and forth. Also, exercise the two dual joy sticks in a circular motion.

Exercising the joysticks help to center them if they are sticking. An out of center joystick could cause the transmitter to fail to establish communication. Turn on the transmitter and let it go through the startup cycle, then push the tilt reset switch.

## STEP 8

If there is still no communication, perform the steps below that correspond to the specific radio model on the unit.

Note: Data labels are on the transmitter and receiver.

H1-00240 and H1-00744

- Steps 9, 10, and 11

H1-01114

- Steps 12 and 13

H1-00787

- Steps 14 and 15

Any unit experiencing a loss of range

- Step 16



## STEP 9

### Radio Types: H1-00240B and H1-00744

Open the receiver with a 4 mm Allen wrench and verify that the top amber (operation) light is on steady with the transmitter OFF and the PTO ON.

If the light is not ON, check the 7.5 amp fuse located on the receiver base board in the lower left-hand corner. If fuse has continuity, check the supply wiring for damage.

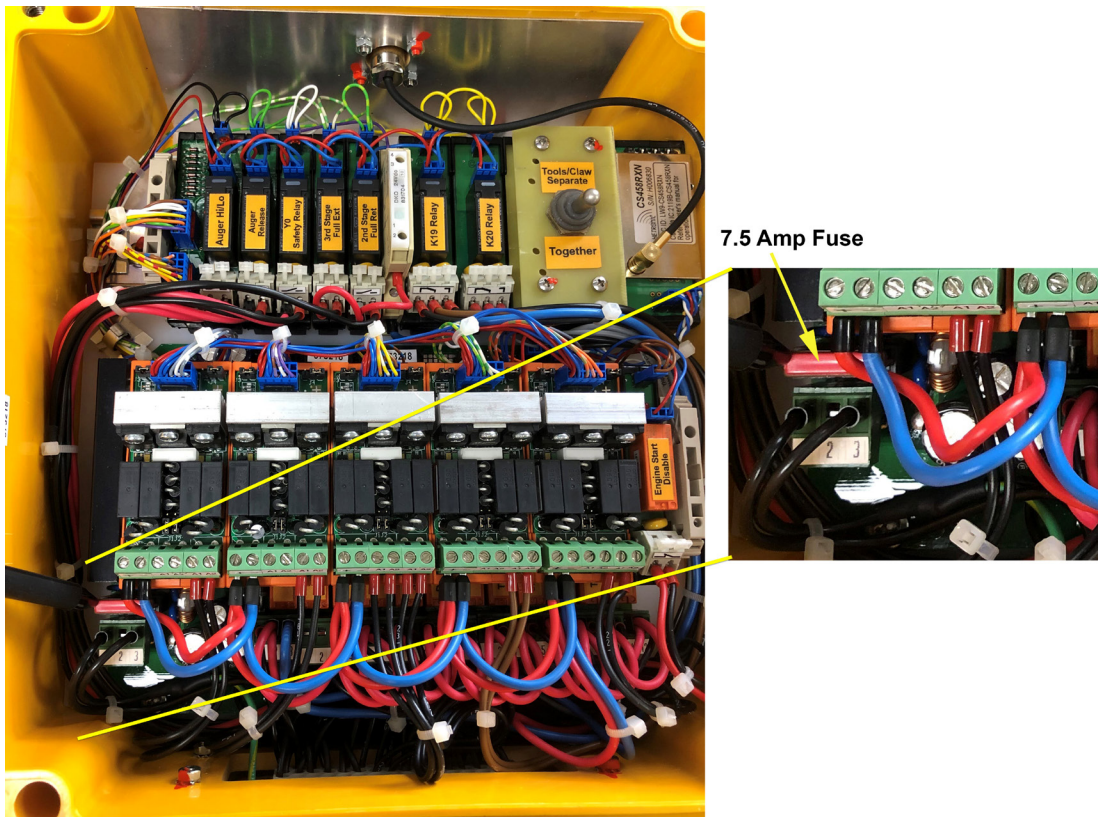

## STEP 10

### H1-00240B and H1-00744 Continued

With the transmitter turned ON, there should be a blinking green (signal) light and a steady amber (normal) light in the receiver. If the green and amber light are not ON, there is no communication.

- Operation Yellow LED = Power to Baseboard (PTO Switch ON)
- Signal Green LED = RF Signal to Baseboard
- Error Red LED = Error on Baseboard
- Normal Yellow LED – Operation Normal/E-stop

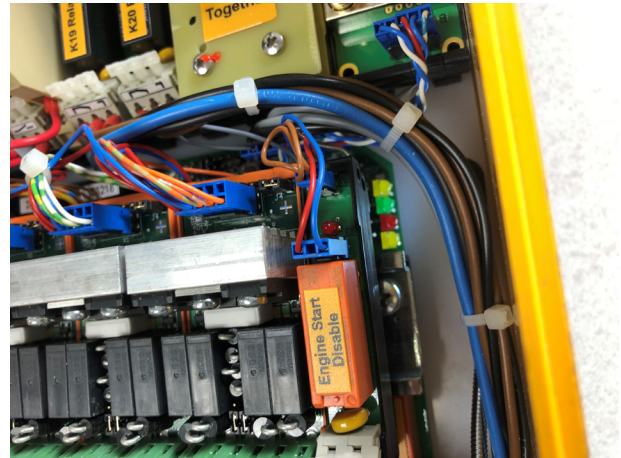
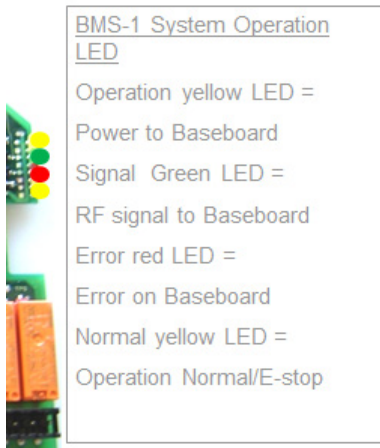

## STEP 11

### H1-00240B and H1-00744 Continued

Open the transmitter with a screw driver and check to see if the RF module Du-box connection on the coder board is properly secured.

Du-box connector is circled in red below.

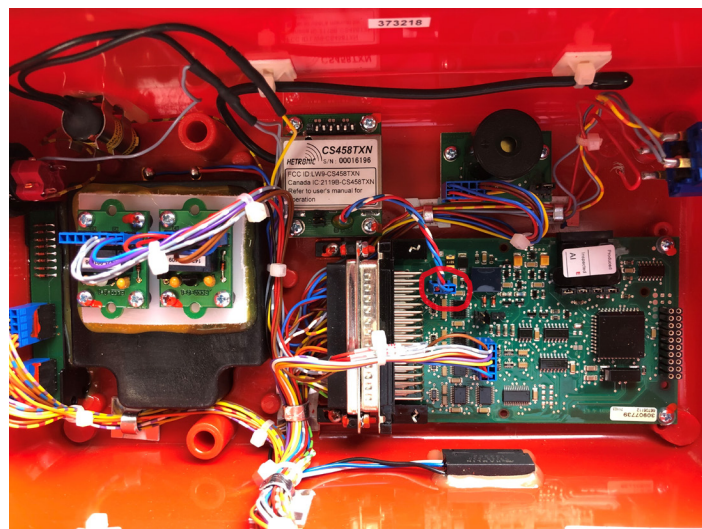

## STEP 12

### Radio Types: H1-01114

Look at the status window on the outside of the receiver for an amber operation LED light that is steadily ON with the transmitter OFF and PTO turned ON.

If the LED is not ON check the 10 amp fuse in the lower left corner of the receiver using a 4mm Allen wrench to remove the cover. If fuse has continuity, check the supply wiring for damage.

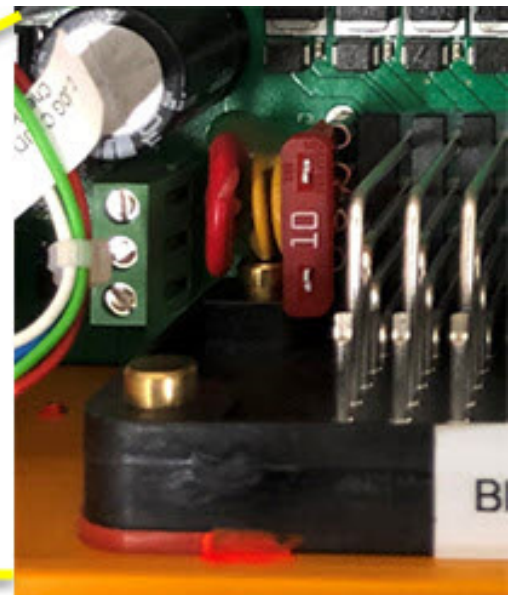
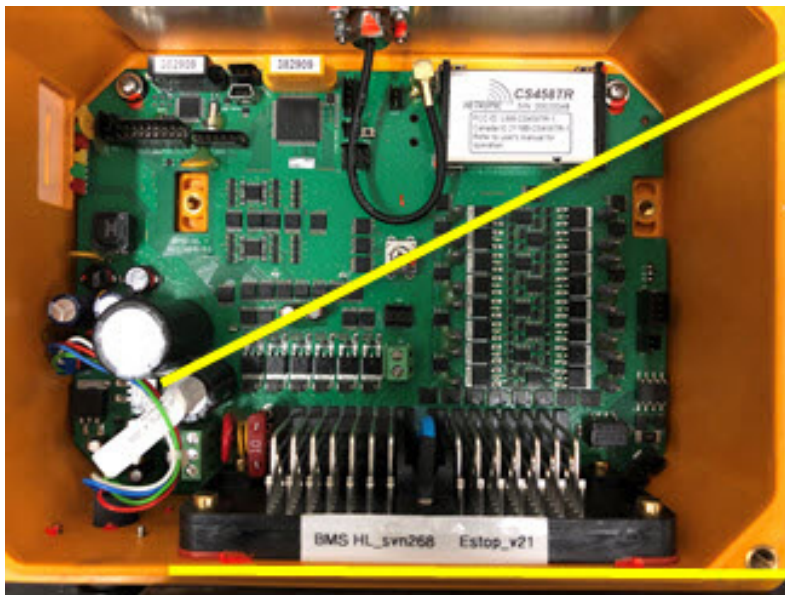
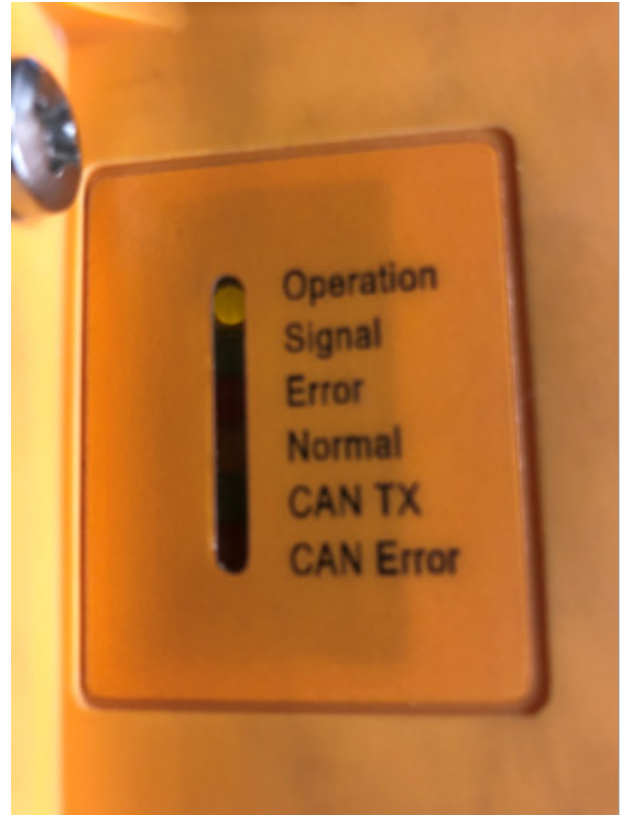



## STEP 13

### H1-01114 Continued

With the transmitter turned ON, there should be a blinking green light for Signal along with a steady amber light for Normal operation.

If no Signal or Normal LED is illuminated, then open the transmitter with a screwdriver and check the friction seating of the RF module. It should be secured on the coder board by the two black retaining clips. Use your thumb and press in the middle of the RF module to reseat the pins into the sockets on the coder board.

After reseating, power transmitter up and recheck for signal and normal LED's.



# STEP 14

## Radio Types: H1-010787

Check that the status window is lit up and showing 001 with the transmitter OFF and the PTO ON.

If the screen is blank, open the receiver with a 4 mm Allen wrench and check the 7.5 amp fuse. If fuse has continuity, check the supply wiring for damage.

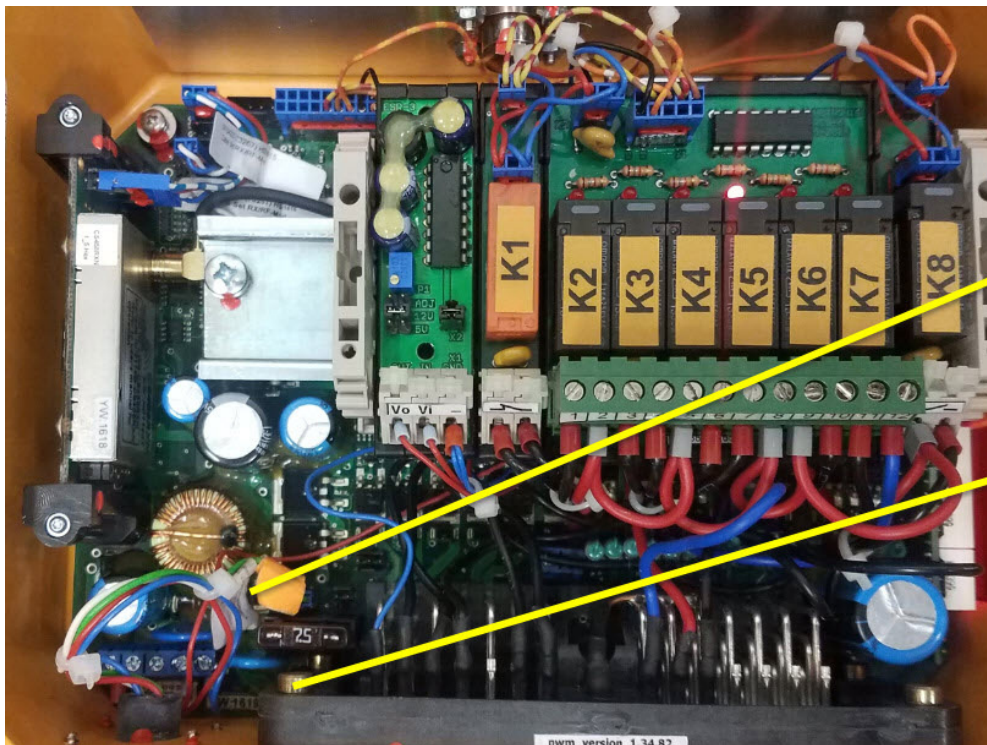
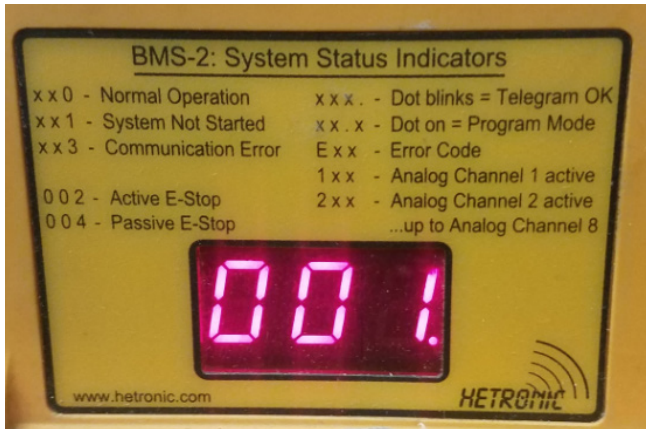

## STEP 15

### H1-010787 Continued

If the status window is displaying 004, open the transmitter with a screwdriver and check the RF module Du-box connection is secure on the coder board.

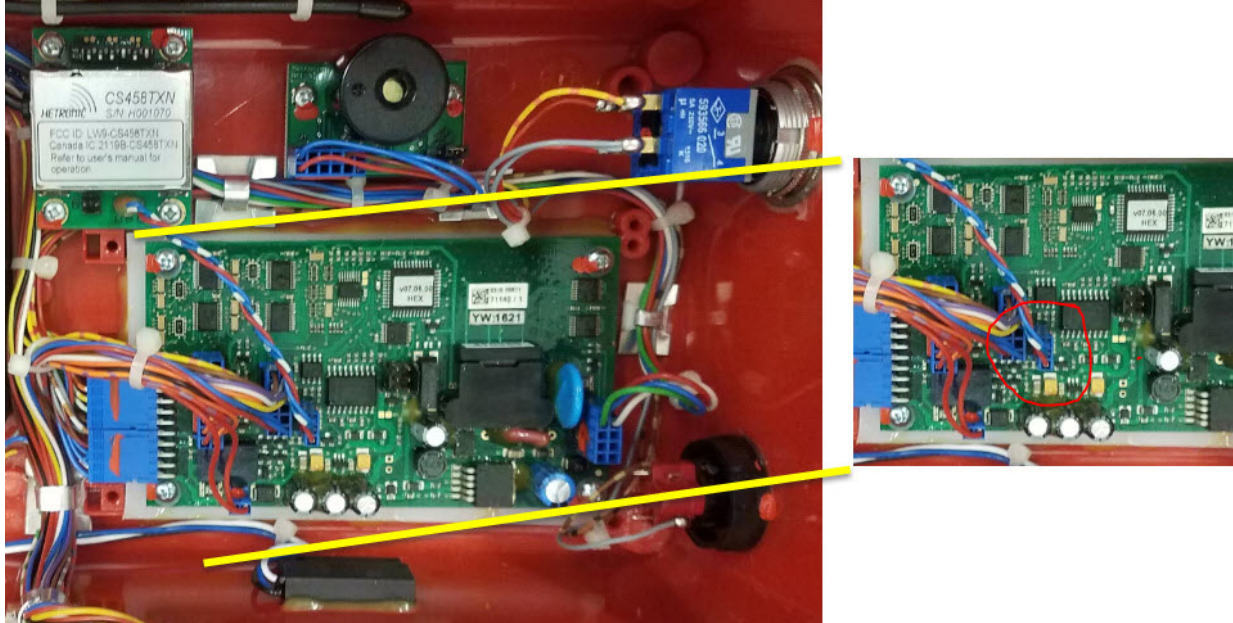

## STEP 16 (All Radio Types)

If the radio is experiencing a loss of range, check the antenna and antenna connections for damage. Repair or replace as necessary.

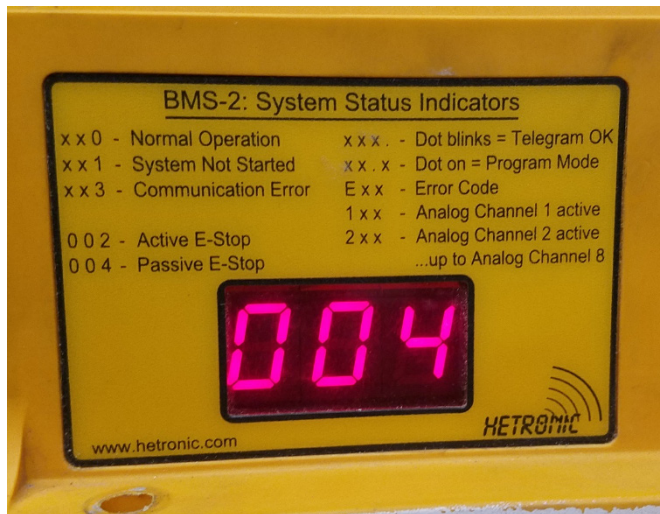

## Conclusion

For further assistance please contact 1-844-TEREX4U (1-844-837-3948) and ask for technical support. Please have the model, serial number of the boom and the radio type number.



FOR FURTHER ASSISTANCE,  
CONTACT THE TEREX UTILITIES TECHNICAL SUPPORT TEAM  
PHONE: **1-844-TEREX4U (1-844-837-3948)** | EMAIL: [\*\*UTILITIES.SERVICE@TEREX.COM\*\*](mailto:UTILITIES.SERVICE@TEREX.COM)

---