

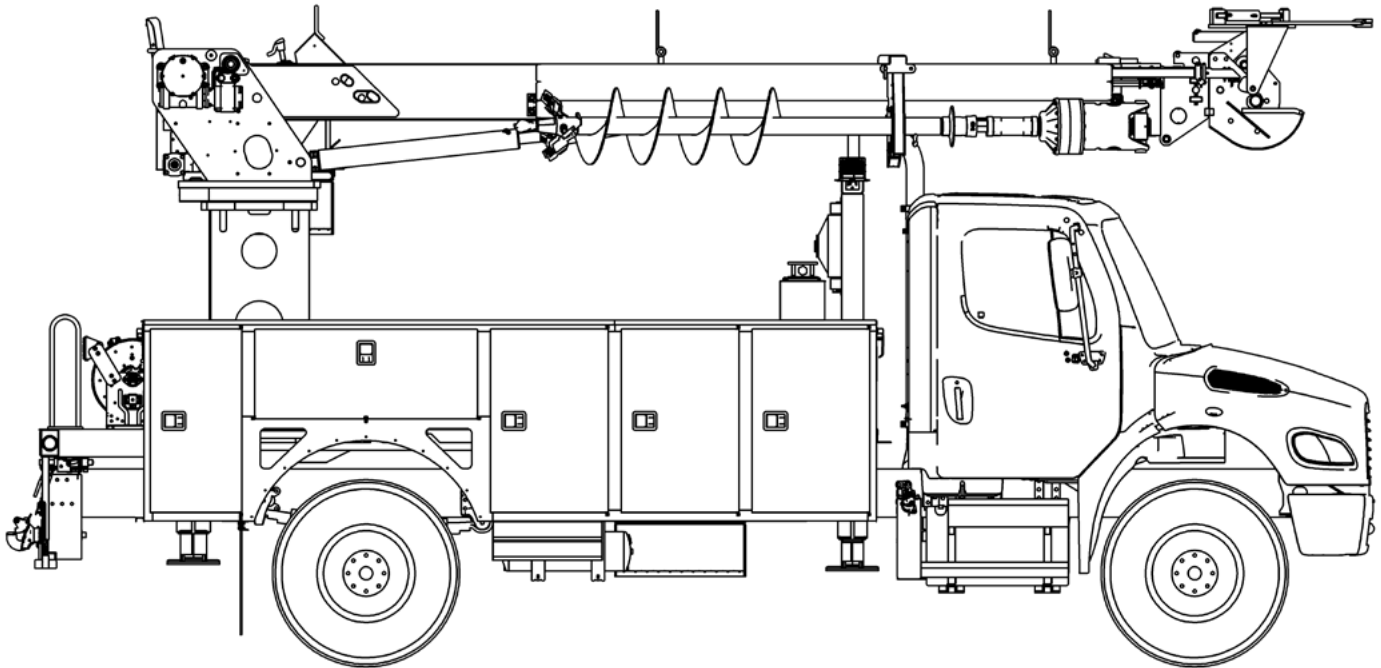

TECH TIPS

ADJUSTING WINCH PILOT PRESSURE ON DIGGER CTI

NO. 179



SERVICE CALL:
ADJUSTING WINCH PILOT
PRESSURE ON DIGGER CTI



MODEL(S):
DIGGER DERRICKS WITH CTI



TOOLS NEEDED:
SIMPLE HAND TOOLS

TEREX UTILITIES TECHNICAL SUPPORT TEAM

PHONE: 1-844-TEREX4U (1-844-837-3948) | EMAIL: UTILITIES.SERVICE@TEREX.COM

! WARNING



Injection Hazard
Fluid escaping under pressure can penetrate skin and result in death or serious injury.



Relieve pressure before disconnecting hydraulic lines.
Stay clear of leaks and pin holes. Use a piece of cardboard or wood to search for leaks. Do not use hand.
Fluid injected into skin must be surgically removed within a few hours by a doctor familiar with this type of injury, or gangrene will result.



DANGER

Failure to obey the instructions and safety rules in the appropriate Operator's Manual and Service Manual for your machine will result in death or serious injury.

Many of the hazards identified in the Operator's Manual are also safety hazards when maintenance and repair procedures are performed.

DO NOT PERFORM MAINTENANCE UNLESS:

- ✓ You are trained and qualified to perform maintenance on this machine.
- ✓ You read, understand and obey:
 - manufacturer's instructions and safety rules
 - employer's safety rules and worksite regulations
 - applicable governmental regulations
- ✓ You have the appropriate tools, lifting equipment and a suitable workshop.

The information contained in this Tech Tip is a supplement to the Service Manual. Consult the appropriate Service Manual of your machine for safety rules and hazards.



TECH TIP 179 | RELEASED 07.28.2022 | VERSION 1.0
©TEREX UTILITIES. ALL RIGHTS RESERVED

CONTENTS

TECH TIP #179

TOC

4

| Set-up the unit
| Remove the covers

INTRODUCTION
STEP 1 - STEP 2

5

| Loosen the jam nut
| Move the upper control winch handle

STEP 3 - STEP 4

6

| Verify the winch can feather
| Retest the controls

STEP 5 - STEP 7

INTRODUCTION

CTI (Controls Top Insulated)

Note: Digger Derrick system pressure should be set before adjusting pilot pressure. This procedure is shown in Tech-tip 2.

Note: This will cause the winch to move. If rope is installed, make sure you have enough slack to avoid damage to rope or unit.

STEP 1

Properly set-up the unit with outriggers deployed before rotating the boom and positioning the boom tip near the ground.

STEP 2

Remove the covers and locate the winch section on the CTI Valve. **Figure 1, 2 and 3.**



FIGURE 1

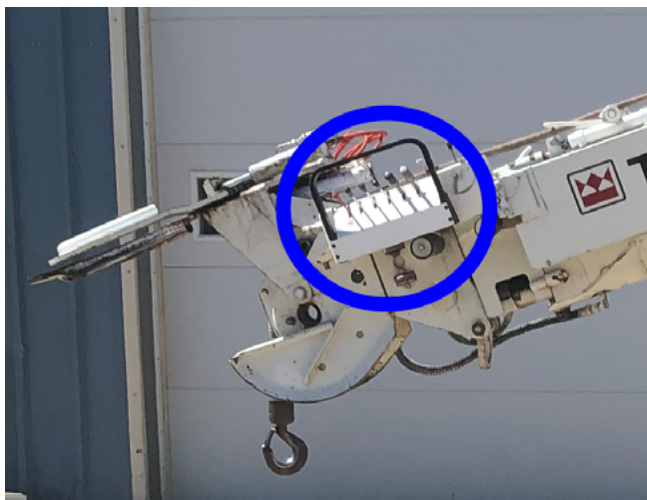

FIGURE 2

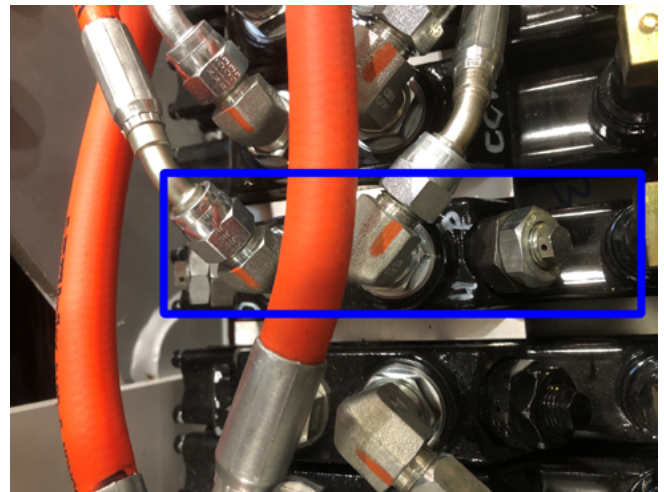

FIGURE 3

STEP 3

Loosen the jam nut on both reliefs in the valve section, then back out both reliefs.

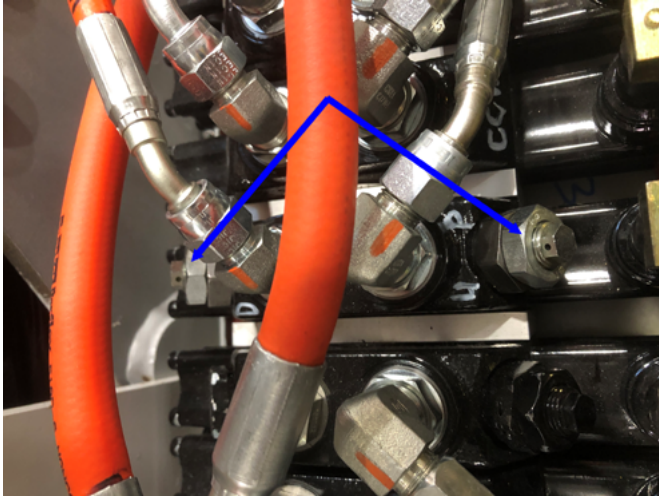

FIGURE 4

STEP 4

Move the upper control winch handle in one direction to engage the winch. Hold the handle and slowly turn in the relief and watch the handle on the digger winch valve at the lower control (LC) station start to move. When the handle is fully stroked on the LC digger winch valve, let go of the handle on the CTI valve. Figure 5 and 6.

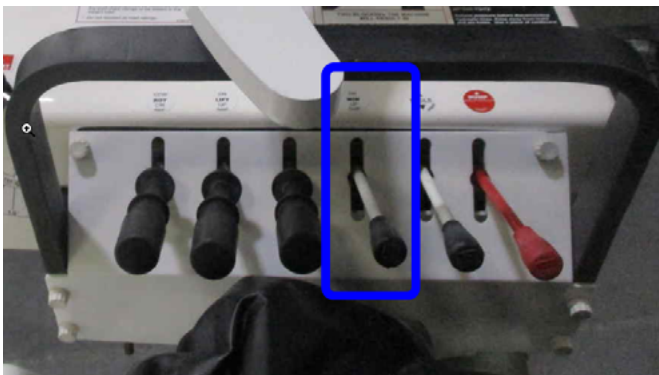

FIGURE 5 - Winch Handle



FIGURE 6



Escaping fluid under pressure can penetrate skin causing serious injury.

Relieve pressure before disconnecting hydraulic lines. Keep away from leaks and pin holes. Use a piece of cardboard or paper to search for leaks. DO NOT use your hand.

STEP 5

Repeat Step 4 with the upper control handle going in the opposite direction.

STEP 6

Verify the winch can feather up and down with the CTI winch control. After this is confirmed, use a wrench to hold the relief adjustments while tightening the jam nuts to prevent movement.

STEP 7

Retest the controls and return the unit to service.



Escaping fluid under pressure can penetrate skin causing serious injury.

Relieve pressure before disconnecting hydraulic lines. Keep away from leaks and pin holes. Use a piece of cardboard or paper to search for leaks. DO NOT use your hand.



FOR FURTHER ASSISTANCE,
CONTACT THE TEREX UTILITIES TECHNICAL SUPPORT TEAM
PHONE: **1-844-TEREX4U (1-844-837-3948)** | EMAIL: **UTILITIES.SERVICE@TEREX.COM**
