

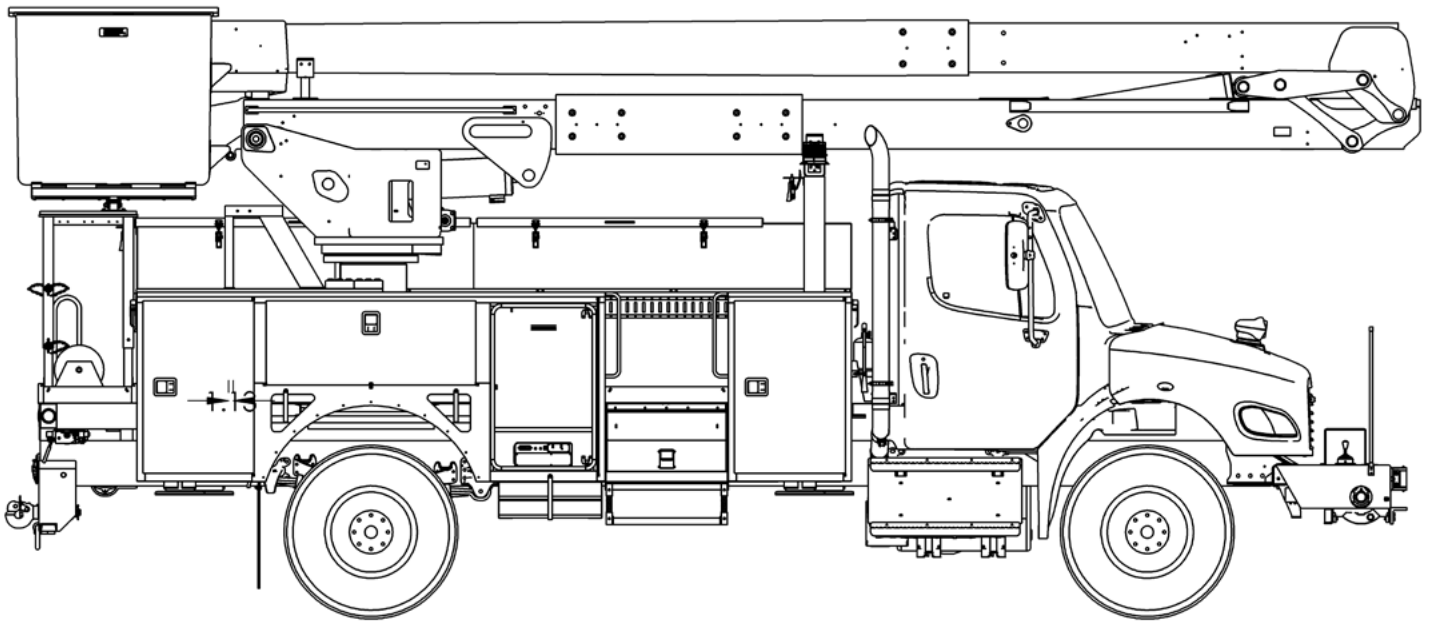

TECH TIPS

SETTING STOP VALVES FOR NON-OVERCENTER FC UNITS

NO. 18



SERVICE CALL:
SETTING STOP VALVES FOR NON-OVERCENTER FC UNITS



MODEL(S):
FC



TOOLS NEEDED:
1/2" WRENCH
1/2" SOCKET
2 LB RUBBER HAMMER
ANGLE INDICATOR OR DIGITAL LEVEL
SCREW DRIVER SET

TEREX UTILITIES TECHNICAL SUPPORT TEAM

PHONE: 1-844-TEREX4U (1-844-837-3948) | EMAIL: UTILITIES.SERVICE@TEREX.COM

! WARNING



Injection Hazard
Fluid escaping under pressure can penetrate skin and result in death or serious injury.



Relieve pressure before disconnecting hydraulic lines.
Stay clear of leaks and pin holes. Use a piece of cardboard or wood to search for leaks. Do not use hand.
Fluid injected into skin must be surgically removed within a few hours by a doctor familiar with this type of injury, or gangrene will result.



DANGER

Failure to obey the instructions and safety rules in the appropriate Operator's Manual and Service Manual for your machine will result in death or serious injury.

Many of the hazards identified in the Operator's Manual are also safety hazards when maintenance and repair procedures are performed.

DO NOT PERFORM MAINTENANCE UNLESS:

- ✓ You are trained and qualified to perform maintenance on this machine.
- ✓ You read, understand and obey:
 - manufacturer's instructions and safety rules
 - employer's safety rules and worksite regulations
 - applicable governmental regulations
- ✓ You have the appropriate tools, lifting equipment and a suitable workshop.

The information contained in this Tech Tip is a supplement to the Service Manual. Consult the appropriate Service Manual of your machine for safety rules and hazards.



TECH TIP 18 | RELEASED 03.03.2022 | VERSION 1.0
©TEREX UTILITIES. ALL RIGHTS RESERVED

CONTENTS

TECH TIP#18

TOC

4

| Set-up the unit

**INTRODUCTION
STEP 1**

5

| Test the upper boom cylinder stop valve

STEP 2 - STEP 3

6

| Test retiming stop valve

STEP 4 - STEP 5

7

| Retime the boom

STEP 6

INTRODUCTION

The FC upper boom has two hydraulic stop valves located at the elbow. One controls when the operator is retiming the compensation system or changes the level of the platform. The other stop valve limits the maximum upper boom up angle.

- The valve closest to the elbow is connected to the retime manifold. It prevents retiming when the upper boom is above the correct angle relative to horizontal.
- The valve furthest from the elbow is connected to the upper boom cylinder and prevents the upper boom from articulating above the correct angle, if the platform is out of level. The stop valve limits the Compensation Cylinder from letting the upper boom go over-center when running the retiming valve, and when running the upper boom up on the FC.

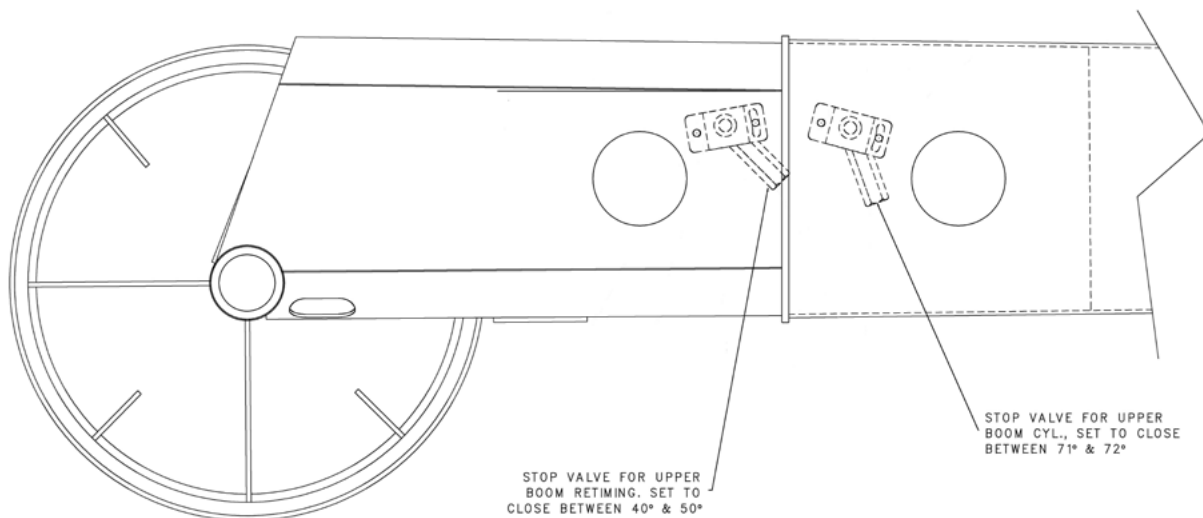

STEP 1

Set the machine up level front to back and side to side. You can verify this by checking that all sides of the turntable below rotation are level.



Top of Pedestal

STEP 2

Temporarily attach an angle indicator or electronic level to the top of the upper boom near the knuckle. This will be used to read the angle that the boom is at, relative to horizontal while setting the stop valves.



DO NOT allow the upper boom to go past 80 degrees.

STEP 3

To test the upper boom cylinder stop valve:

- With the booms stored, raise the upper boom 10 degrees with the upper boom retiming valve
- Operate the upper boom control in the “UP” direction slowly
- The boom must stop at the correct angle of 72–74 degrees
- If the boom does not stop at the correct angle lower the boom back down and refer to Step 6 to make adjustments to the valve furthest from the elbow (Red Circle)
- Repeat this procedure until the boom stops at the proper angle

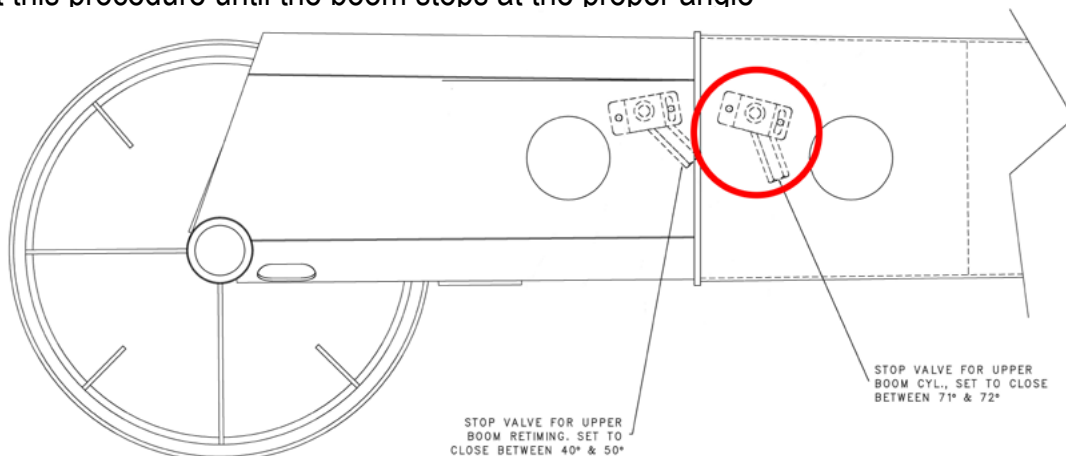

STEP 4

To test the retiming stop valve:

- Raise the upper boom to about 35 degrees with the upper boom “Up” control
- Use the retime control at the lower control station to raise the upper boom
- The boom should stop when the angle indicator reads the correct angle of 40-50 degrees
- If the boom does not stop at the correct angle lower the boom back down and refer to Step 6 to make adjustments to the stop valve closest to the elbow (Red Circle)
- Repeat this procedure until the boom stops at the proper angle

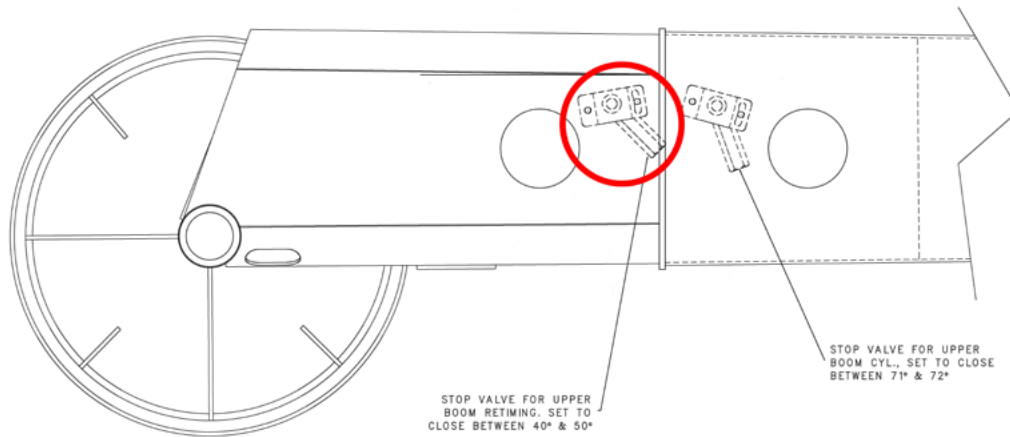

STEP 5

To change the angle that the boom stops at, adjust the angle of the stop valve referencing the picture below.

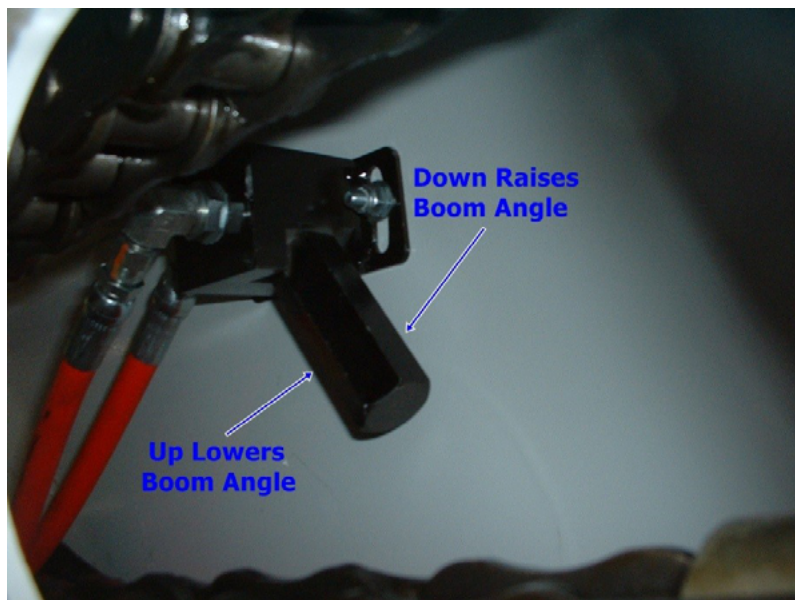



FOR FURTHER ASSISTANCE,
CONTACT THE TEREX UTILITIES TECHNICAL SUPPORT TEAM
PHONE: **1-844-TEREX4U (1-844-837-3948)** | EMAIL: [**UTILITIES.SERVICE@TEREX.COM**](mailto:UTILITIES.SERVICE@TEREX.COM)
