

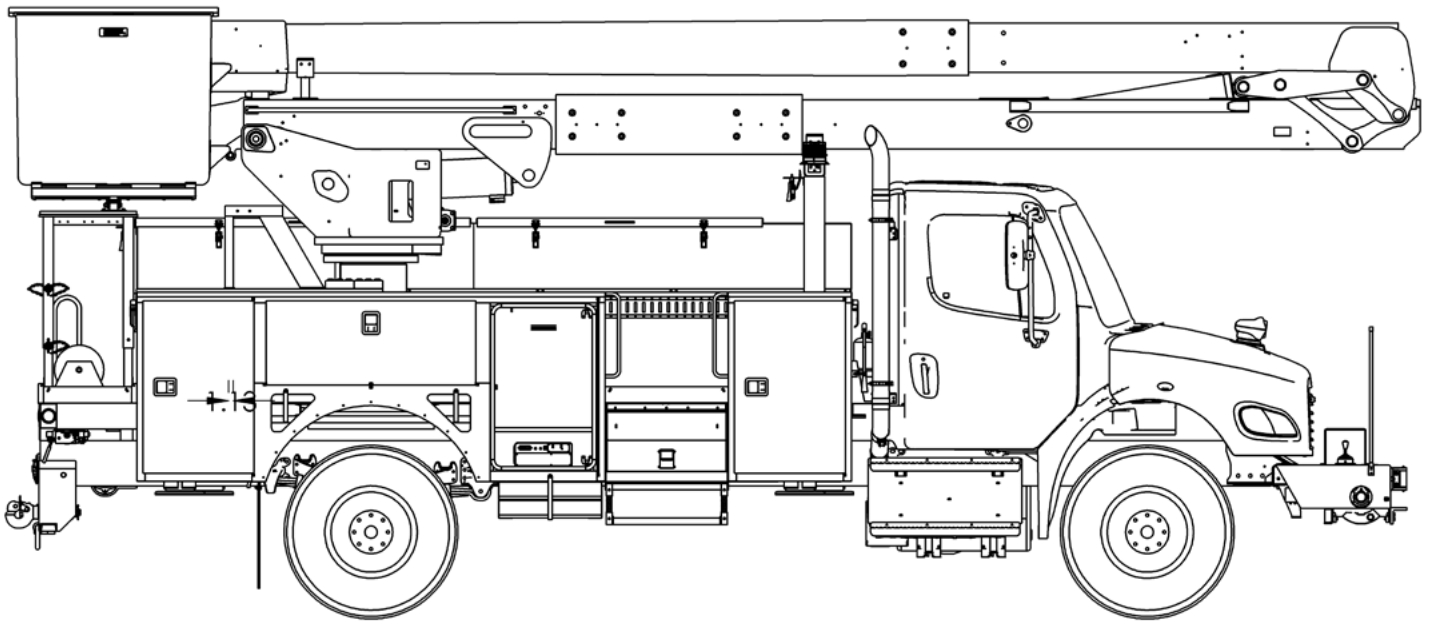

# TECH TIPS

INSTALLING AND CONFIGURING MOTOTUNE SOFTWARE

NO. 19



**SERVICE CALL:**  
INSTALLING AND CONFIGURING  
MOTOTUNE SOFTWARE



**MODEL(S):**  
HYPOWER 408V SYSTEMS



**TOOLS NEEDED:**  
LAPTOP WITH USB PORTS

TEREX UTILITIES TECHNICAL SUPPORT TEAM

PHONE: 1-844-TEREX4U (1-844-837-3948) | EMAIL: [UTILITIES.SERVICE@TEREX.COM](mailto:UTILITIES.SERVICE@TEREX.COM)



## **DANGER**

Failure to obey the instructions and safety rules in the appropriate Operator's Manual and Service Manual for your machine will result in death or serious injury.

Many of the hazards identified in the Operator's Manual are also safety hazards when maintenance and repair procedures are performed.

## **DO NOT PERFORM MAINTENANCE UNLESS:**

- ✓ You are trained and qualified to perform maintenance on this machine.
- ✓ You read, understand and obey:
  - manufacturer's instructions and safety rules
  - employer's safety rules and worksite regulations
  - applicable governmental regulations
- ✓ You have the appropriate tools, lifting equipment and a suitable workshop.

The information contained in this Tech Tip is a supplement to the Service Manual. Consult the appropriate Service Manual of your machine for safety rules and hazards.



TECH TIP 19 | RELEASED 03.03.2022 | VERSION 1.0  
©TEREX UTILITIES. ALL RIGHTS RESERVED

# CONTENTS

## TECH TIP#XX

### TOC

4 | *Download the software*  
**STEP 1 - STEP 3**

5 | *Install Kvaser*  
**STEP 4 - STEP 5**

7 | *Install Mototune*  
**STEP 6**

8 | *Copy folders*  
**STEP 7 - STEP 8**

11 | *Paste Folders*  
**STEP 11**

12 | *Start Mototune.*  
**STEP 12**

13 | *Configure MotoServer*  
**STEP 13**

16 **APPENDIX A**

## STEP 1

To receive the most current version of the Mototune software and files, contact Jason Julius at [jason.julius@terex.com](mailto:jason.julius@terex.com). The download is approximately 35MB, be sure to have an adequate internet connection.

## STEP 2

Once you receive the files, save them to your desktop. The Mototune files will be provided in a .zip format. To extract the files from the .zip package, right click on the Mototune.zip file and choose extract all. Follow the wizard directions to extract the files to your desktop.

A folder named Mototune will be created on your desktop with the subfolders shown below.

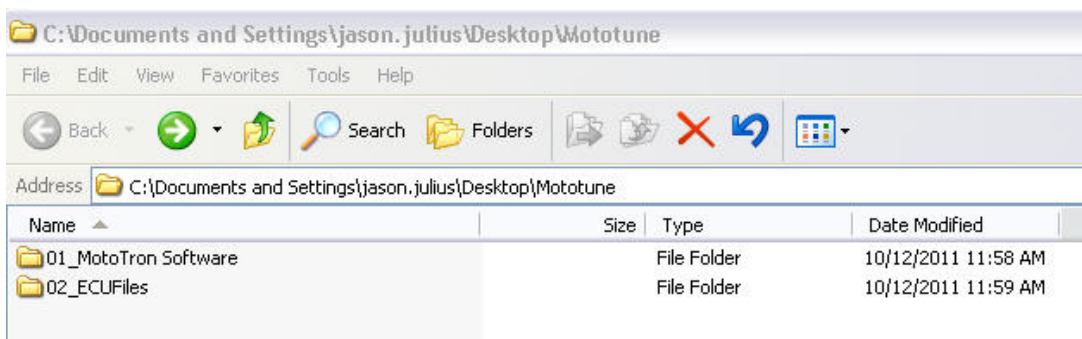

## STEP 3

Open the Mototune folder, inside the contents should appear similar to the illustration below.

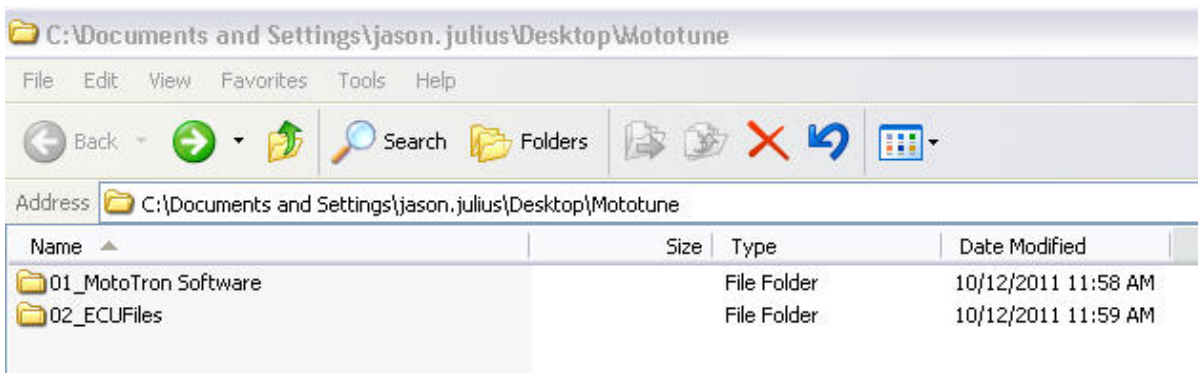

## STEP 4

Double-click on the 01\_MotoTron Software folder.

These three folders contain the software that needs to be installed from Kvaser, Motoserver, and Mototune needed to interface with the HyPower™ Hybrid system.

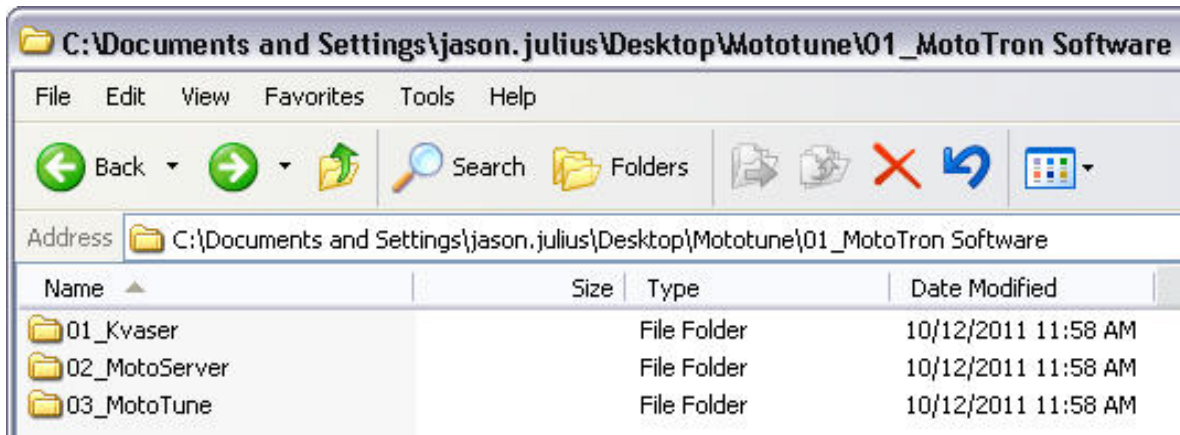

## STEP 5

Double-click on the 01\_Kvaser folder and then double-click on the kvaser...exe executable file inside to start the installation.

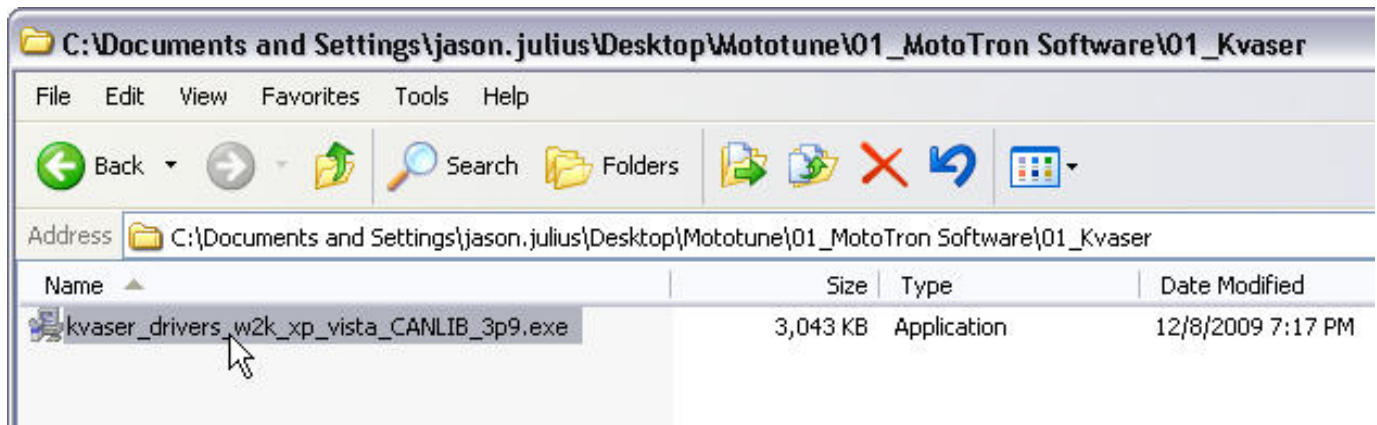

## STEP 5 (CONTINUED)

Follow the prompts of the installation wizard to complete the installation.

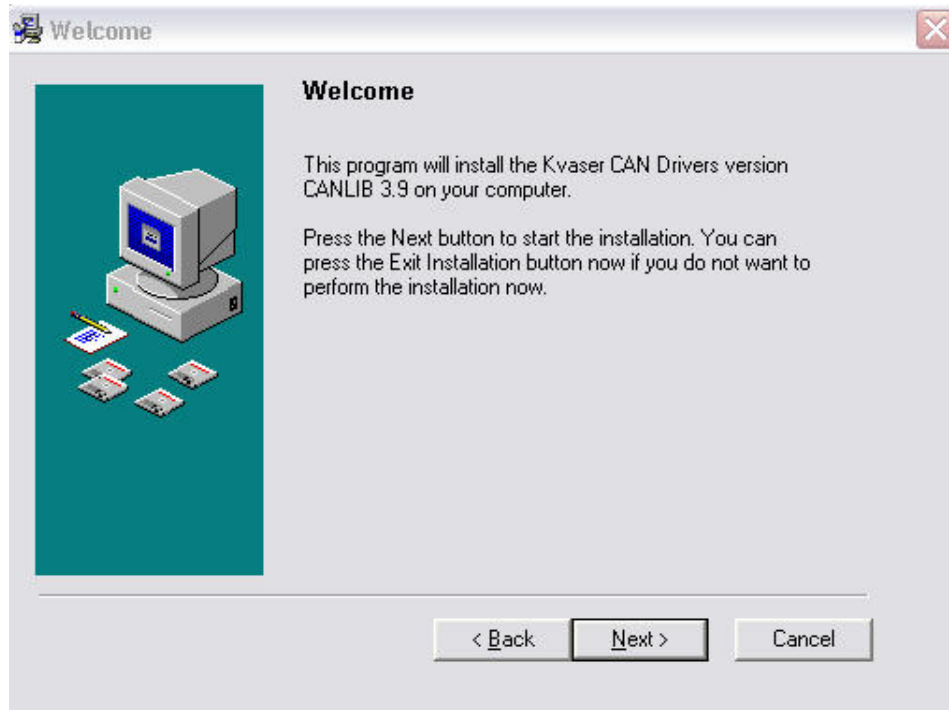

Double-click the Motoserver executable file to start the next installation.

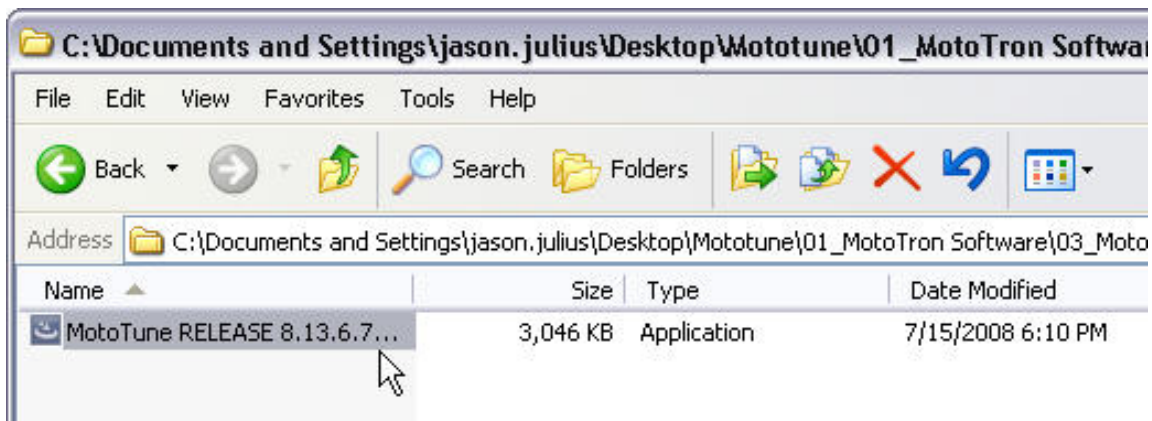

Follow the prompts of the installation wizard to complete the installation.

## STEP 6

Once the installation is complete, click on the back button to return to the 01\_Mototron Software folder and then double-click the 03\_Mototune folder.

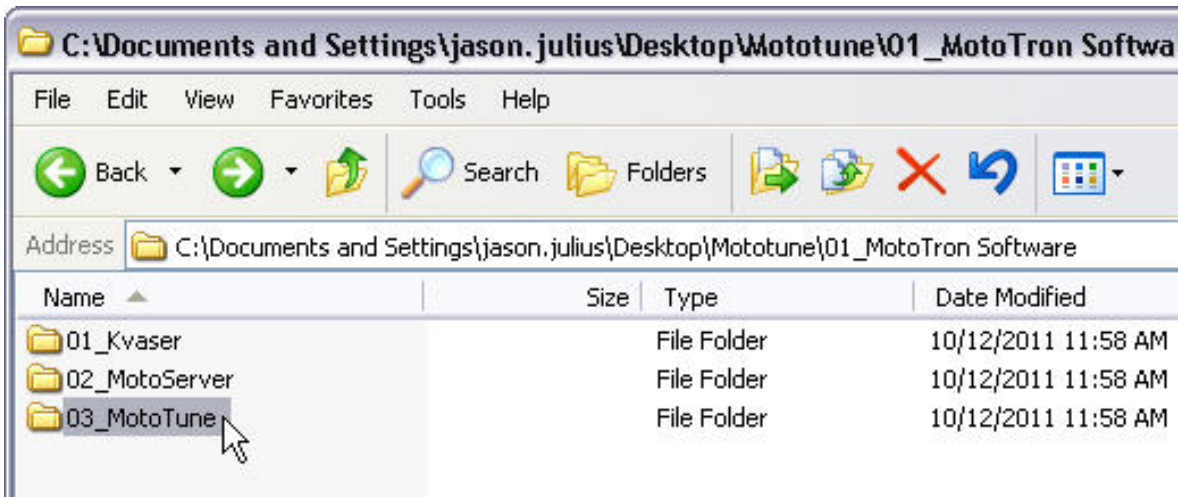

Double-click the Mototune Release executable file to start the final installation.

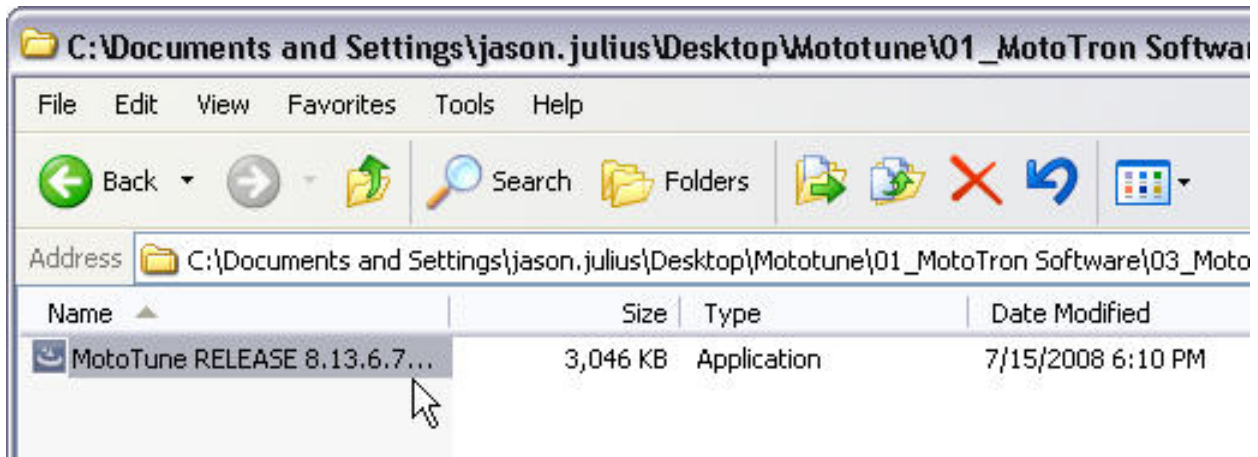

Follow the prompts of the installation wizard to complete the installation.

When the installation is completed, click on the back button twice to return to the main Mototune folder.

## STEP 7

Double-click on the 02\_ECUFiles folder.

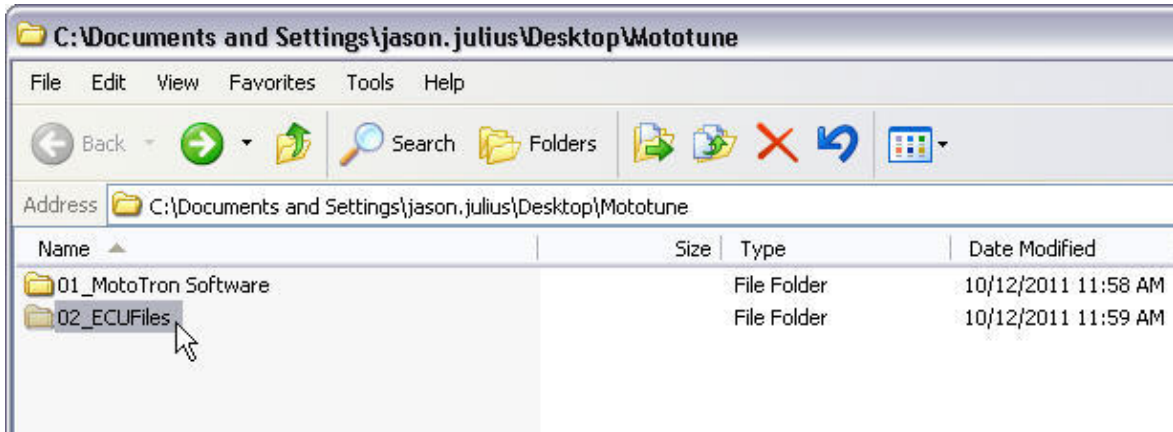

Inside the 02\_ECUfiles folder are 3 subfolders: Displays, Programs, and TDBDLL folders. These folders will be copied into a folder on your C: drive created by the previous installations. Follow the instructions on the next pages to copy and paste these files into the correct folder.

## STEP 8

Select all 3 folders using your mouse, then right-click on one of the folders and choose copy from the pop-up menu.

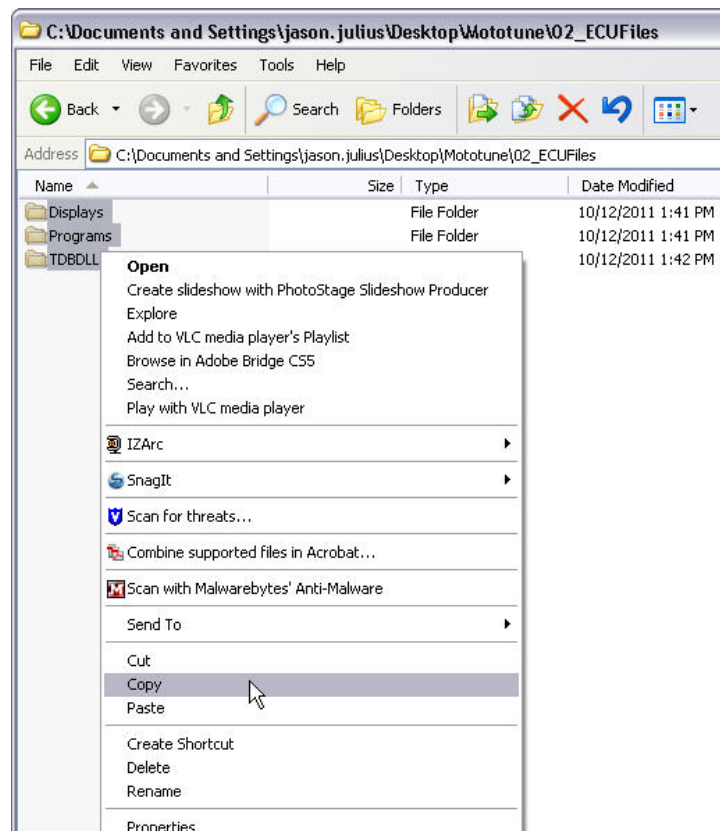



## STEP 9

Next go to Start and click on the My Computer icon.



# STEP 10

Double-click on the Local Disk (C:) to view the folders on your hard drive.

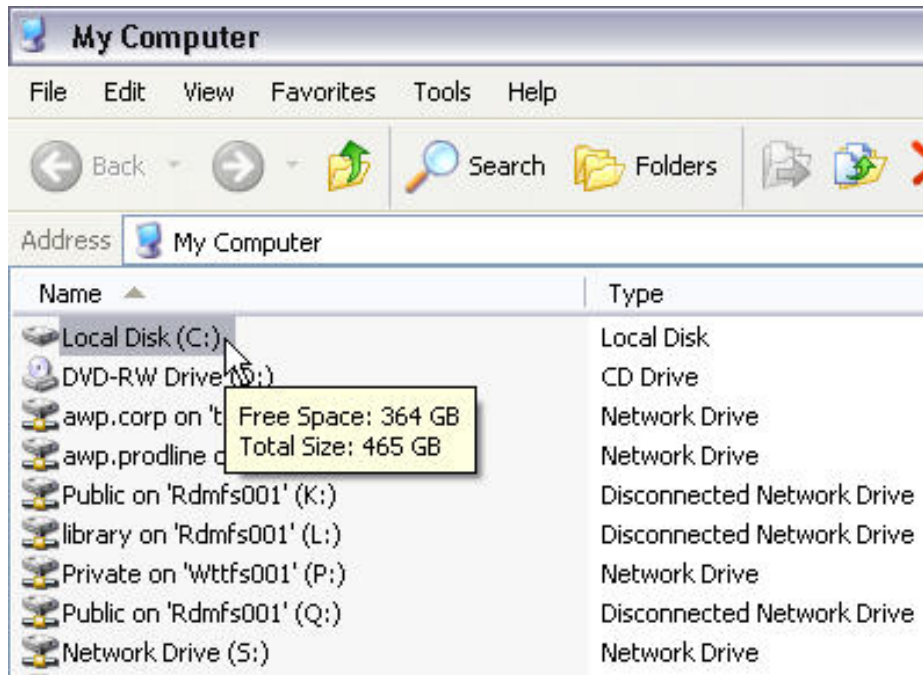

Find the folder labeled ECUFiles and double-click the folder to open it.

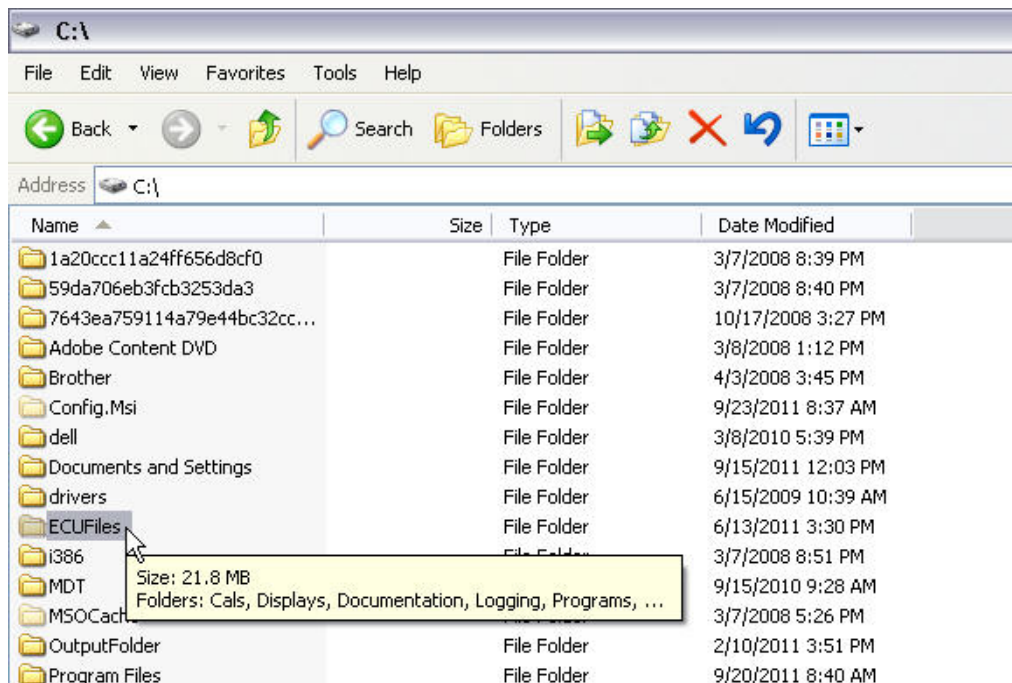

# STEP 11

The ECUFiles folder should look similar to the image below.

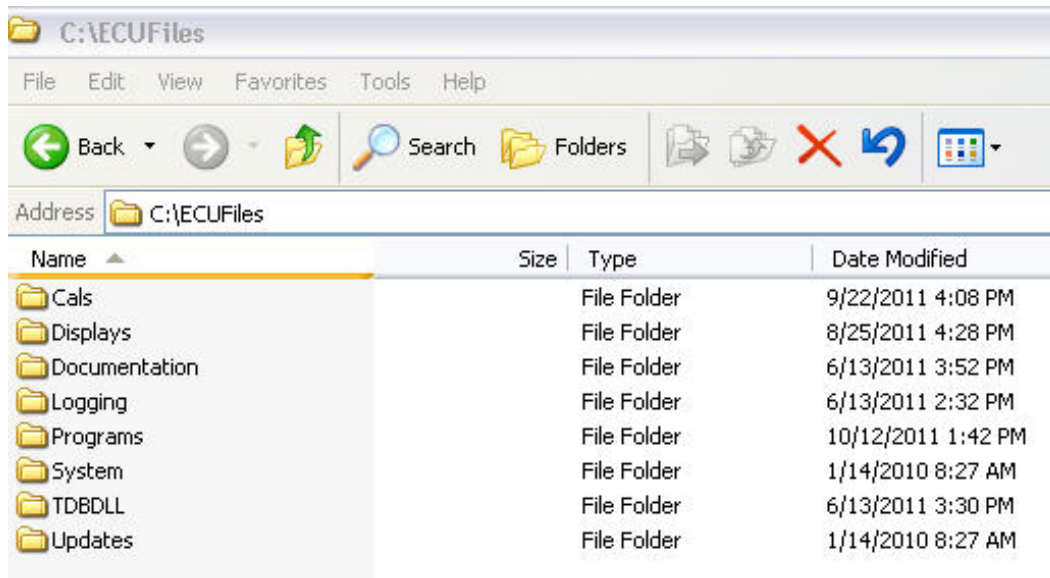

Right-click in an empty space inside the folder and choose paste to move the folders you copied in step 8 to the new location.

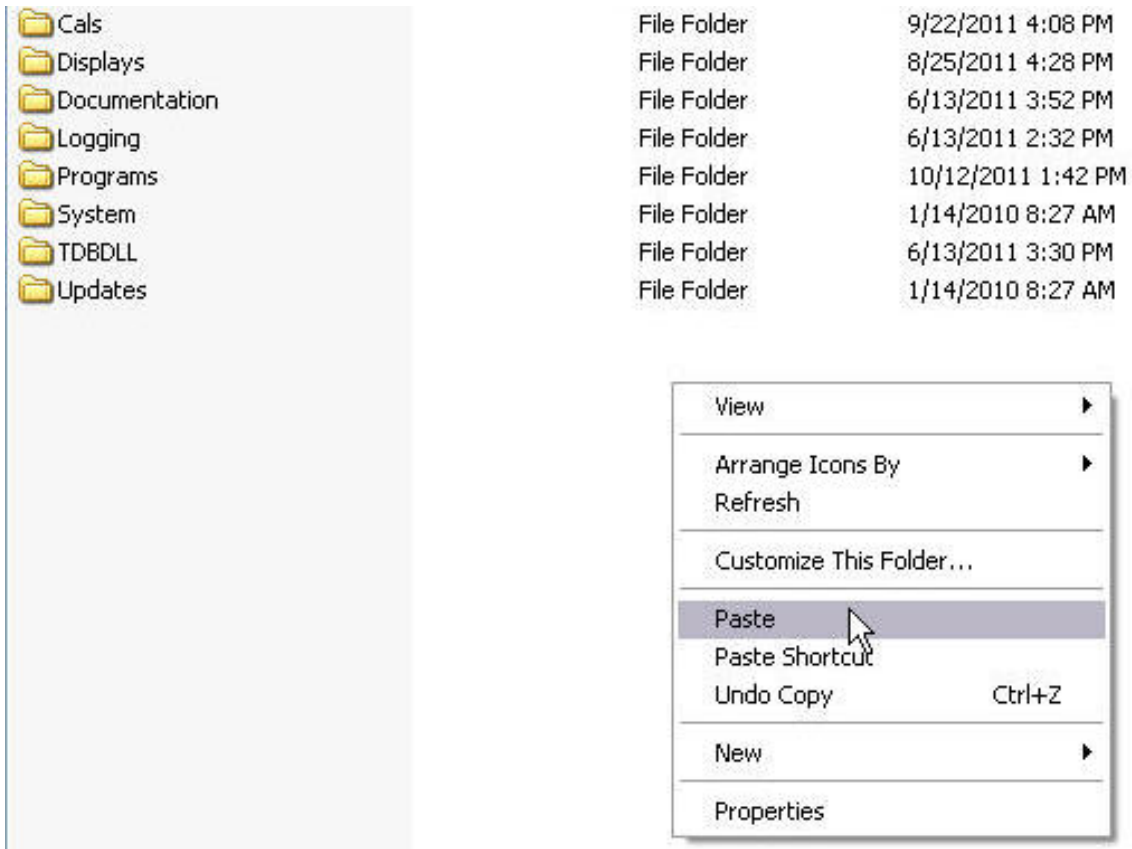

## STEP 11 (CONTINUED)

After selecting paste, you will be prompted with a Confirm Folder Replace dialogue box. Click on the “Yes to All” button to complete the file transfer.



Once the files are finished copying, the ECUFiles window can be closed.

---

## STEP 12

To open Mototune, click on the Start Menu and go to All Programs\Mototools\Mototune.

Click on the Mototune menu to start the program. The first time Mototune is used, the MotoServer settings need to be updated.

Locate the MotoServer icon in the bottom right-hand corner of the task bar. The icon will look similar to the images below.



\*Note, the icon on the left indicates that the USB license key has not been inserted. The license key is not required to change the configuration.

## STEP 13

To change the MotoServer configuration, right-click on the MotoServer icon and click on ports.

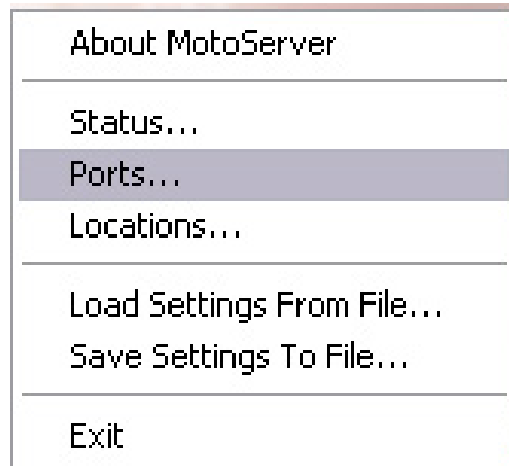

The Port Configuration Window will be displayed.

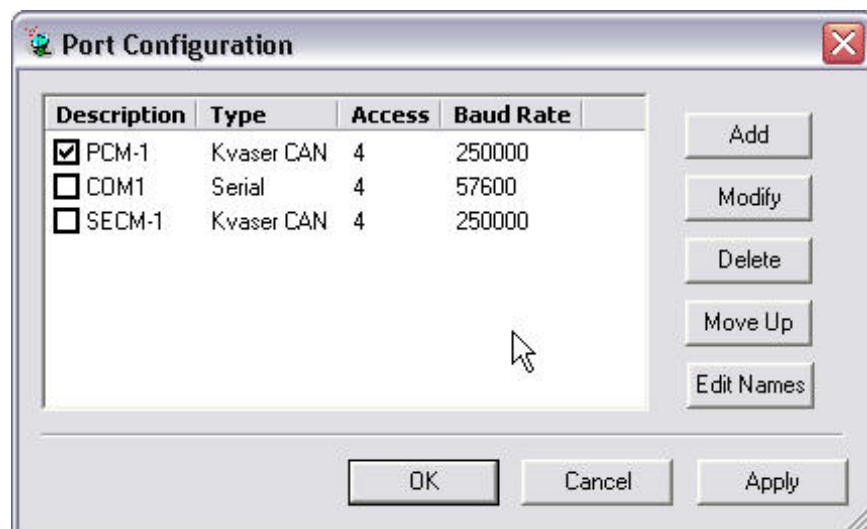

## STEP 14

The Baud Rate for the PCM-1 port needs to be set to 500000 to correctly communicate with the HyPower™ system. To edit the PCM-1 port, click on the PCM-1 description to highlight it and then click on Modify.

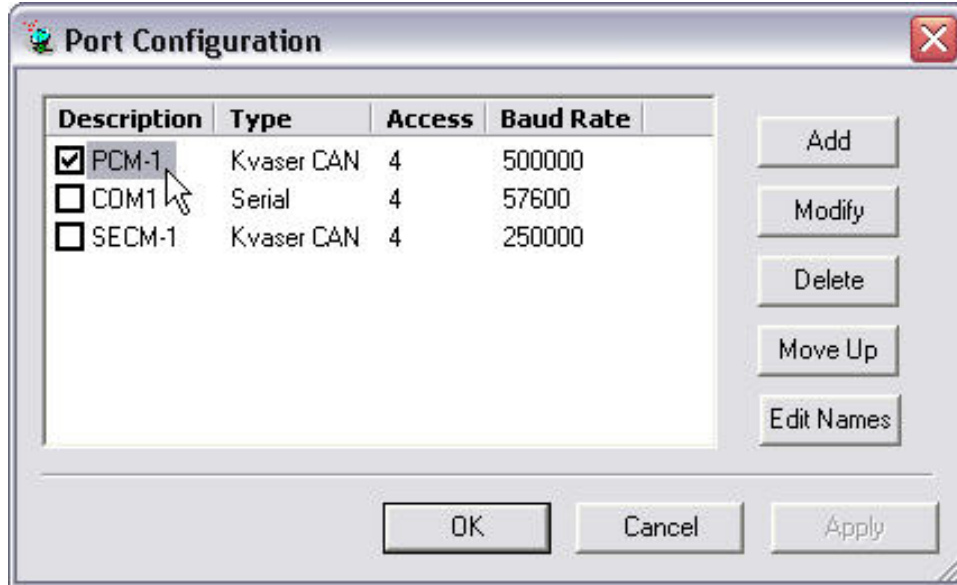

Change the Baud Rate to 500000, and then click OK to close the Modify window.

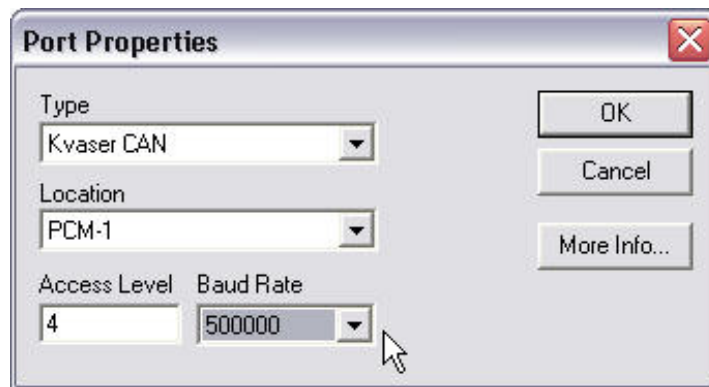

## STEP 15

If there is a check mark next to COM1 or SECM-1, remove the check mark and then click on OK to close the Port Configuration window.

## CONCLUSION

The installation of Mototune is now complete and ready to interface with the 408V HyPower™ system.

# APPENDIX: A

Computers with Windows 7 or 64-bit operating systems may require updated drivers from Kvaser. If you are unable to connect to the HyPower system through Mototune after the first install, follow the directions below to update the Kvaser drivers.

To download drivers, go to the [Kvaser website](#), select “Driver” as the download type, “CAN/USB” for the type, and “Kvaser Leaf Light HS” as the product. Click on the “Kvaser Drivers for Windows” file displayed in the results.

type:  ← ←

product:  ← ←

include Older Versions:

include Beta Versions:

## Results

Filename	Type	Description	Version
Kvaser DIADEM driver	Driver	This free driver for National Instrument's DIAdem supports all CAN hardware from Kvaser.	1.0.0
Kvaser Drivers for Windows	Driver	Windows drivers for all our CAN hardware. Please check release notes for information on which Windows versions are supported. It also contains a driver for the virtual CAN bus.	V4.6.0a
Kvaser LINUX Driver and SDK <small>Beta</small>	Driver	Linux driver and SDK. This is a BETA version for Kvaser PCican/PCicanx, Kvaser PCicanII, Kvaser PC104+, Kvaser PCicanx II, Kvaser USBcan II, Kvaser Memorator*, Kvaser Leaf family, Kvaser Memorator Pro**, Kvaser USBcan Pro and VirtualCAN. For LAPcan and LAPcan II, you should use	V4.78

Download and install the executable file to update the Kvaser drivers.





FOR FURTHER ASSISTANCE,  
CONTACT THE TEREX UTILITIES TECHNICAL SUPPORT TEAM  
PHONE: **1-844-TEREX4U (1-844-837-3948)** | EMAIL: **[UTILITIES.SERVICE@TEREX.COM](mailto:UTILITIES.SERVICE@TEREX.COM)**

---