

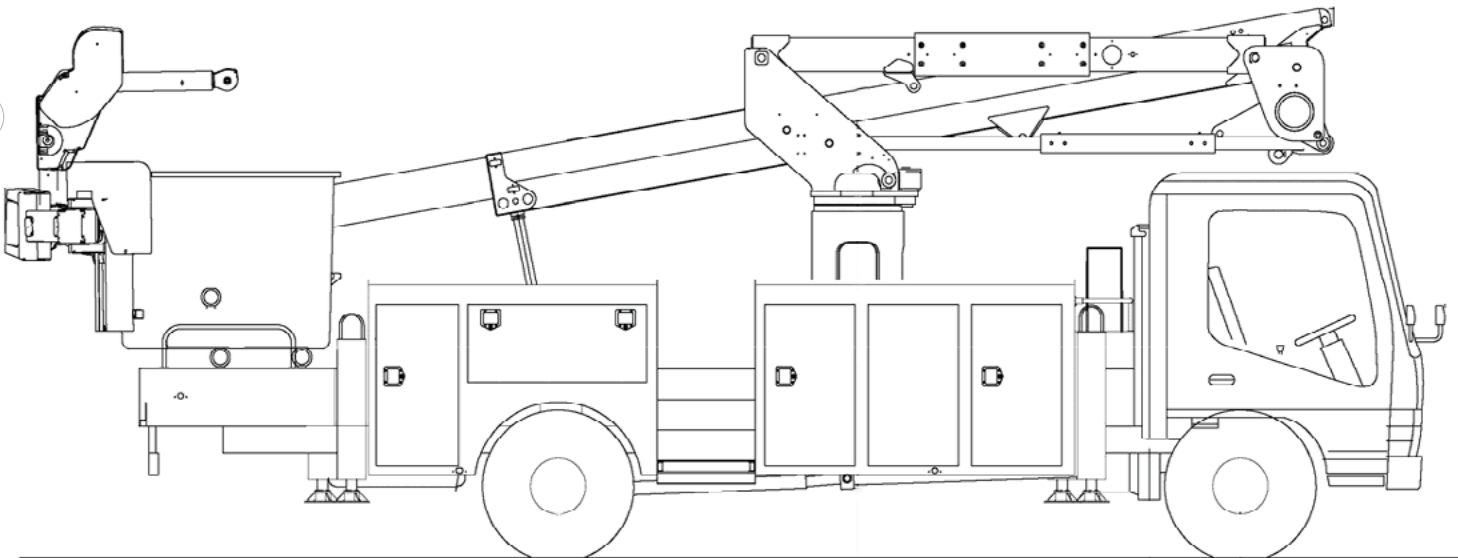

TECH TIPS

PROGRAMMING THE MOTOR CONTROLLER ON A 48V HYPOWER™

NO. 31



SERVICE CALL:
PROGRAMMING THE MOTOR
CONTROLLER ON A 48V
HYPOWER™



MODEL(S):
ALL TEREX UTILITIES UNITS
EQUIPPED WITH THE 48V
HYPOWER™ SYSTEM



TOOLS NEEDED:
CURTIS PROGRAMMING DEVICE
PHILLIPS SCREWDRIVER

TEREX UTILITIES TECHNICAL SUPPORT TEAM

PHONE: 1-844-TEREX4U (1-844-837-3948) | EMAIL: UTILITIES.SERVICE@TEREX.COM



DANGER

Failure to obey the instructions and safety rules in the appropriate Operator's Manual and Service Manual for your machine will result in death or serious injury.

Many of the hazards identified in the Operator's Manual are also safety hazards when maintenance and repair procedures are performed.

DO NOT PERFORM MAINTENANCE UNLESS:

- ✓ You are trained and qualified to perform maintenance on this machine.
- ✓ You read, understand and obey:
 - manufacturer's instructions and safety rules
 - employer's safety rules and worksite regulations
 - applicable governmental regulations
- ✓ You have the appropriate tools, lifting equipment and a suitable workshop.

The information contained in this Tech Tip is a supplement to the Service Manual. Consult the appropriate Service Manual of your machine for safety rules and hazards.



TECH TIP 31 | RELEASED 03.14.2022 | VERSION 1.0
©TEREX UTILITIES. ALL RIGHTS RESERVED

CONTENTS

TECH TIP#31

4

| *Boot up the system*

| *Locate the panel*

STEP 1 - STEP 2

5

| *Remove the connector*

| *Select parameters*

STEP 3 - STEP 4

7

| *Set Turn On Time Threshold*

| *Select Motor Item in Parameters*

STEP 5 - STEP 6

9

| *Adjust speed settings*

| *Verify programming*

STEP 7 - STEP 9

STEP 1

Boot up the 48V system, consult the operator's manual for operational instructions.

STEP 2

Locate the panel displaying PTO hours and hybrid battery status. This panel is typically installed in one of the rear compartments. Once the panel has been located, remove the four Phillips screws holding it in place.

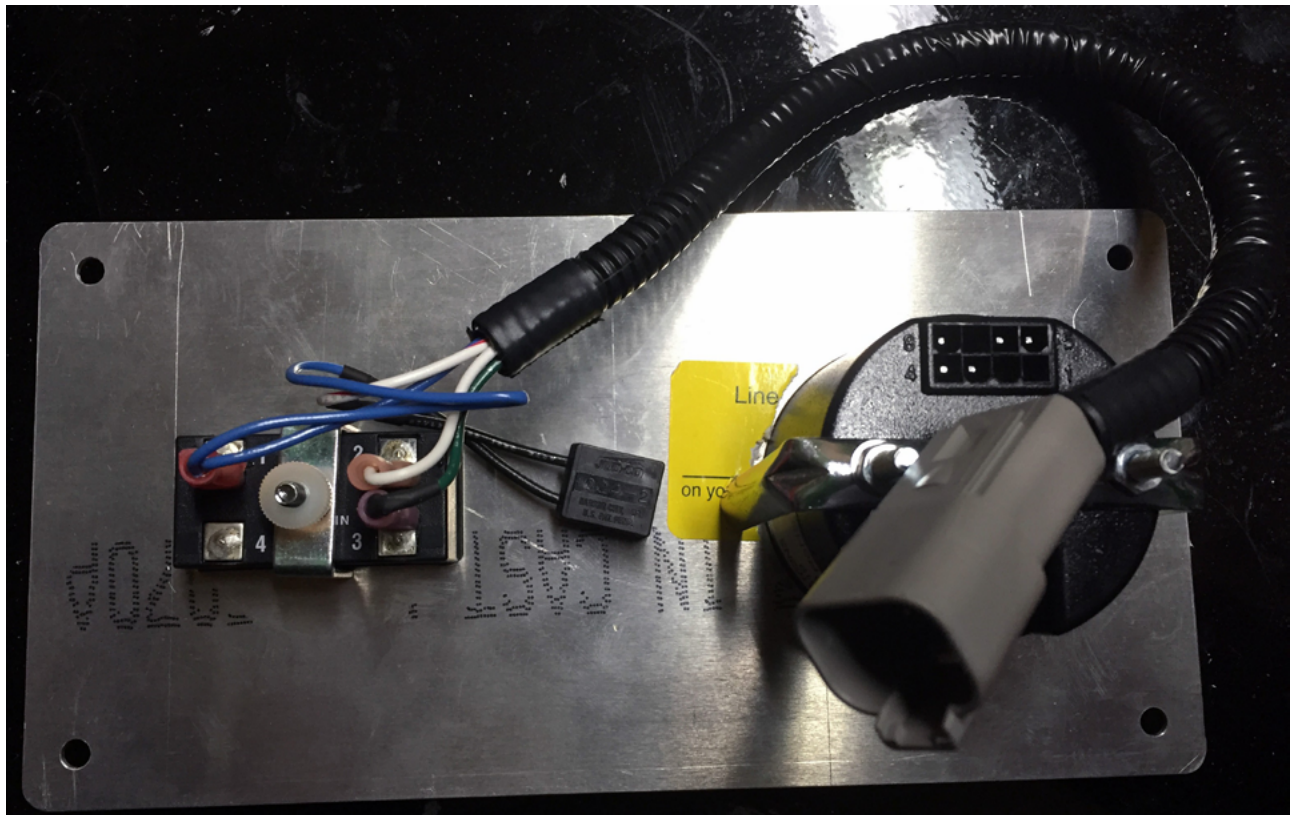

STEP 3

Remove the connector at the back of the battery display and connect it to the Curtis Programming Device. After approximately 10 seconds, the Curtis Programming Device should power up.



STEP 4

Once the system boots up, use the arrow keys to select the Parameters menu.



STEP 4 (CONTINUED)

Next select Output Parameters.

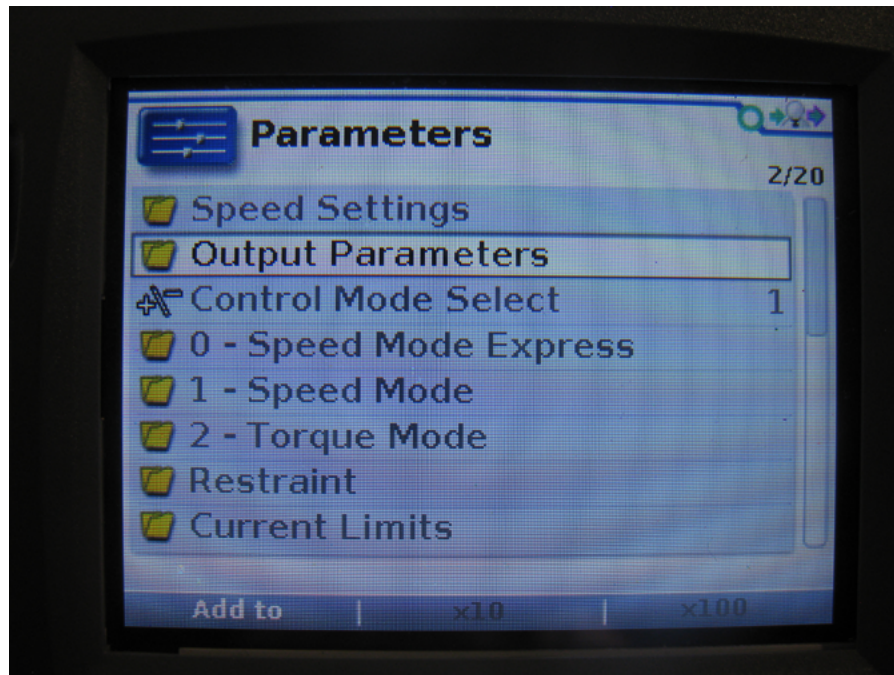

The variable, **Turn on Voltage** should be set to 44.50V. This value represents the voltage that triggers the engine to start and recharge the unit. If this value is incorrect, use the arrow keys to select it and change the set value.

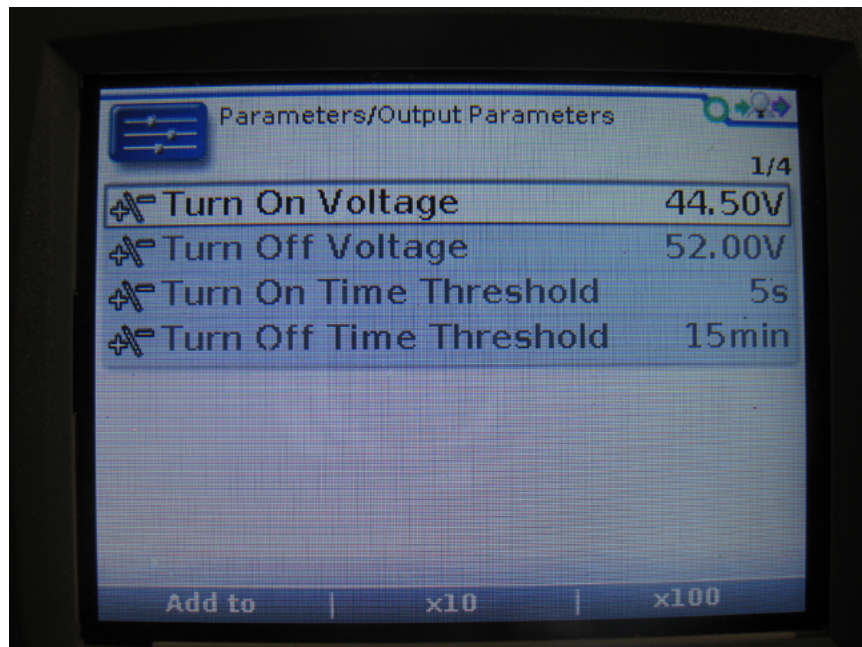

STEP 5

Next look at the variable, Turn On Time Threshold. This threshold is the amount of time that the voltage must stay below the 44.50V before the system starts to recharge. This value should be set to 5 seconds, select it to modify the set value.

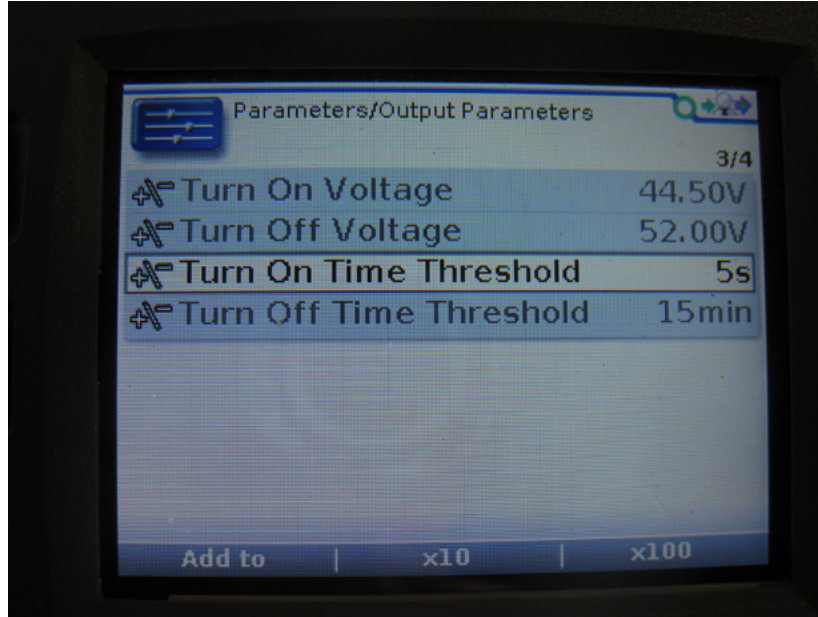

STEP 6

Select the Motor menu item in the parameters menu.

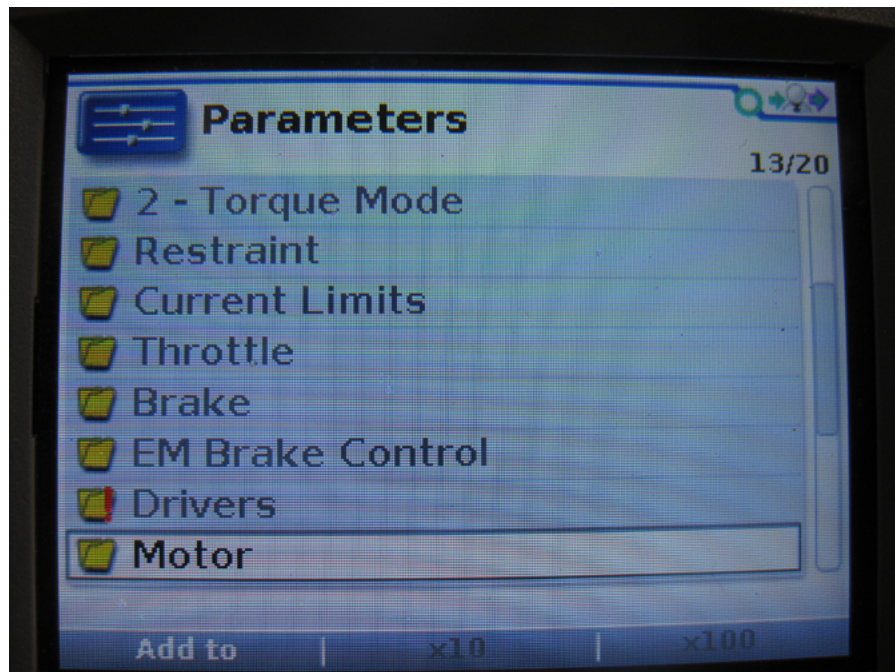

STEP 6 (CONTINUED)

Next, choose Temperature Control.

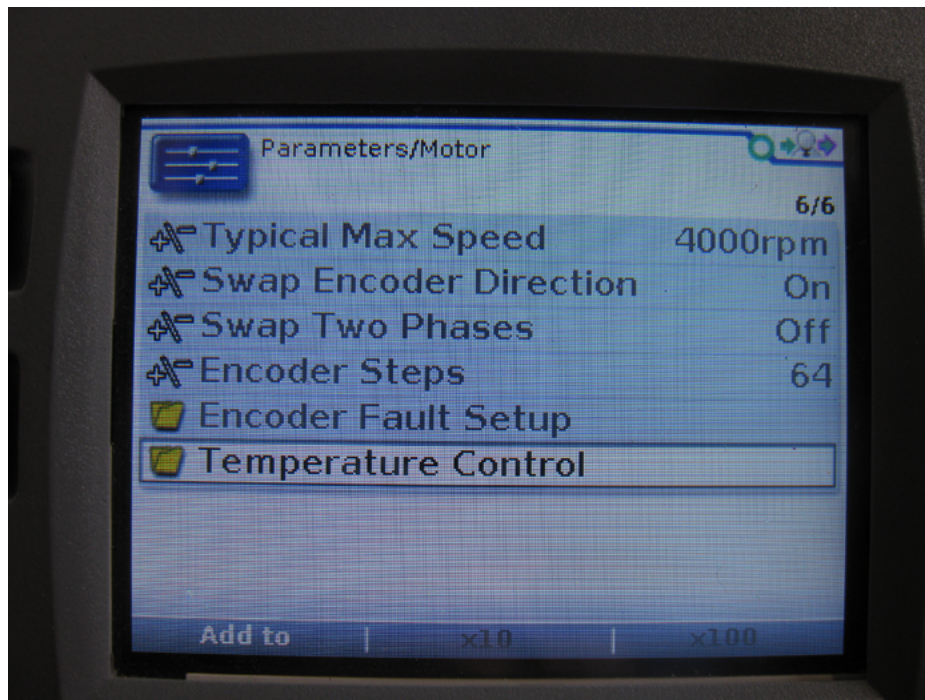

The Sensor Enable variable in this screen should be set to OFF. If it is ON, select the variable to modify it.

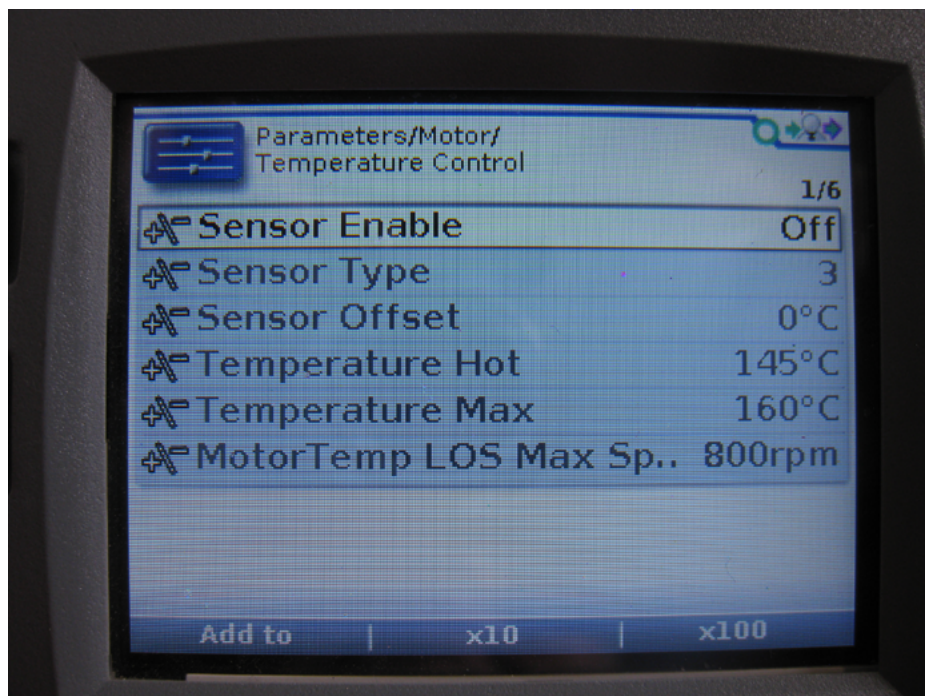

STEP 7

To adjust the speed settings, select the Programming menu, Speed Settings, and then RPM mode 1. Set the RPM to produce 5 GPM at 1800 psi. Then select RPM mode 2 and set it to get 7 GPM at 1800 psi.

For units with single flow hydraulics, set RPM mode 2 to get the required flow (5 or 7 GPM) at 1800 psi.

STEP 8

Nothing needs to be done to save changes, the modifications are made immediately.

STEP 9

To verify the programming, operate the unit in hybrid mode until the batteries reach 44.5 Volts. Once the voltage remains at or below 44.5 V for at least 5 seconds the chassis engine should start to charge the hybrid system.



FOR FURTHER ASSISTANCE,
CONTACT THE TEREX UTILITIES TECHNICAL SUPPORT TEAM
PHONE: **1-844-TEREX4U (1-844-837-3948)** | EMAIL: **UTILITIES.SERVICE@TEREX.COM**
